

ISTRUZIONI DI MONTAGGIO

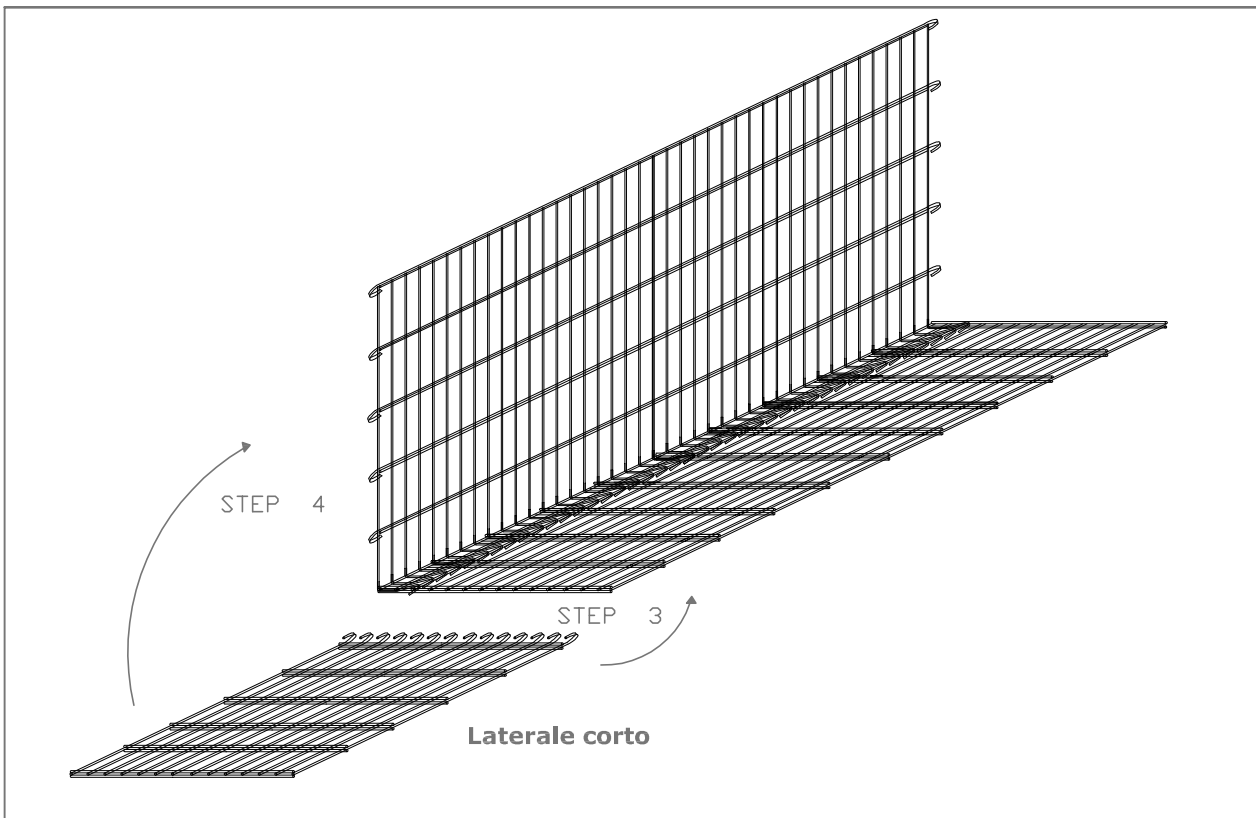

ISTRUZIONI DI MONTAGGIO

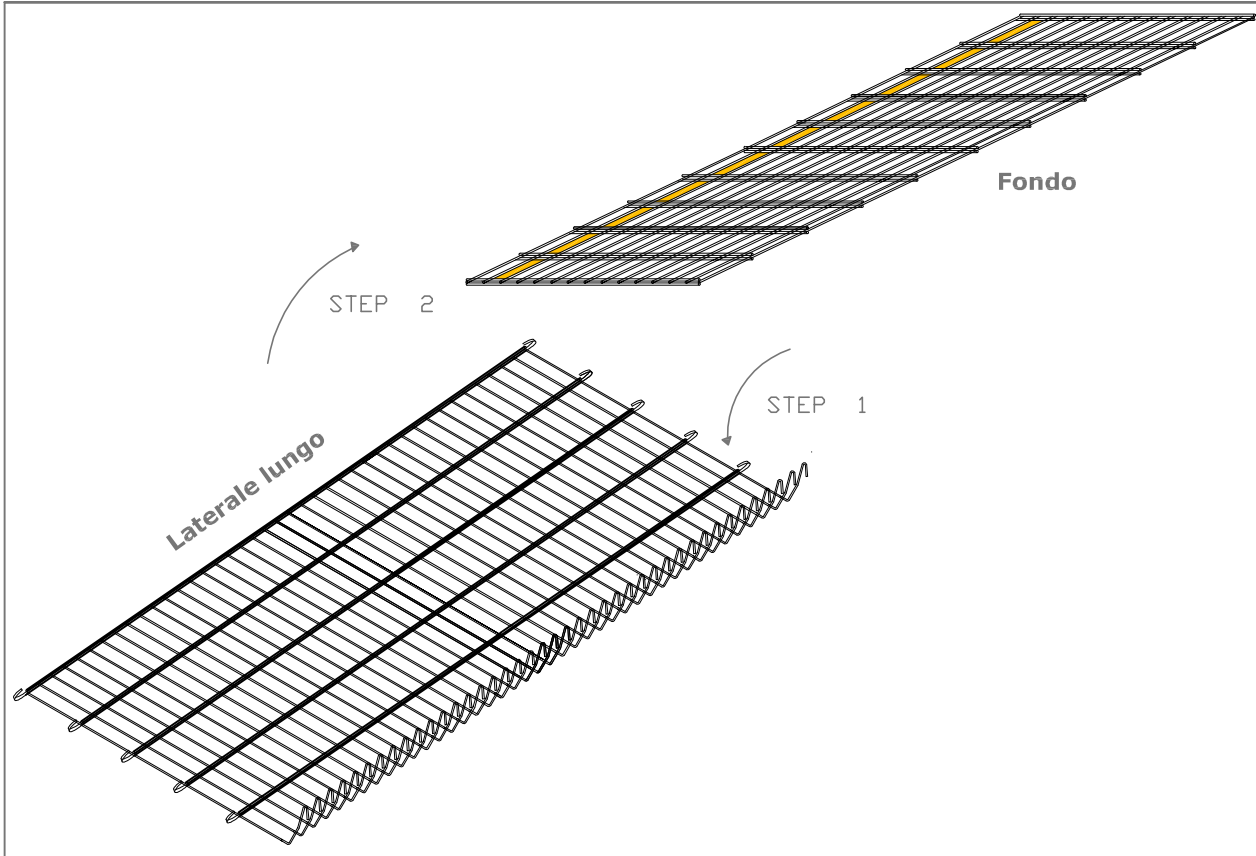
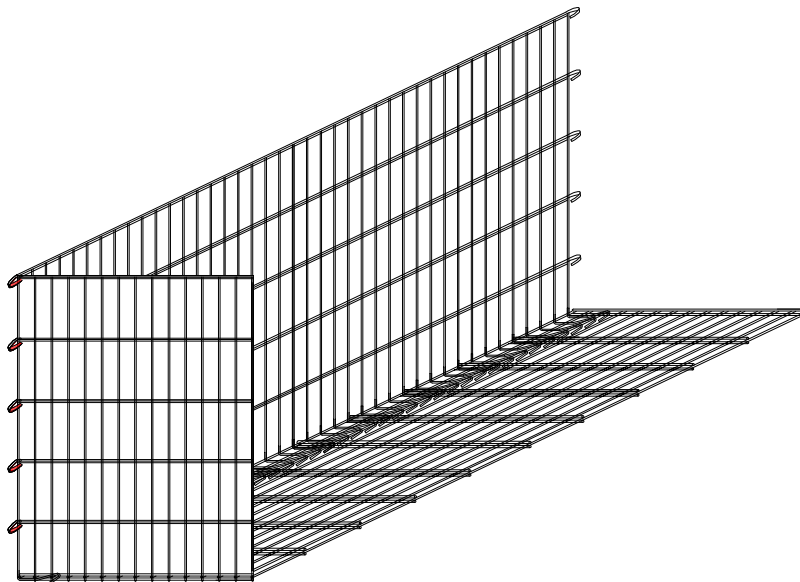
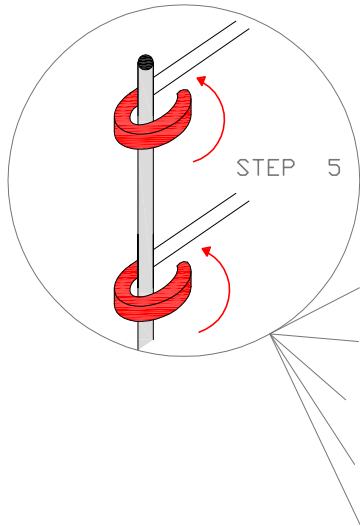

Gabbia con marcatura

PHONONIX

Con il sistema altamente
fono-assorbente

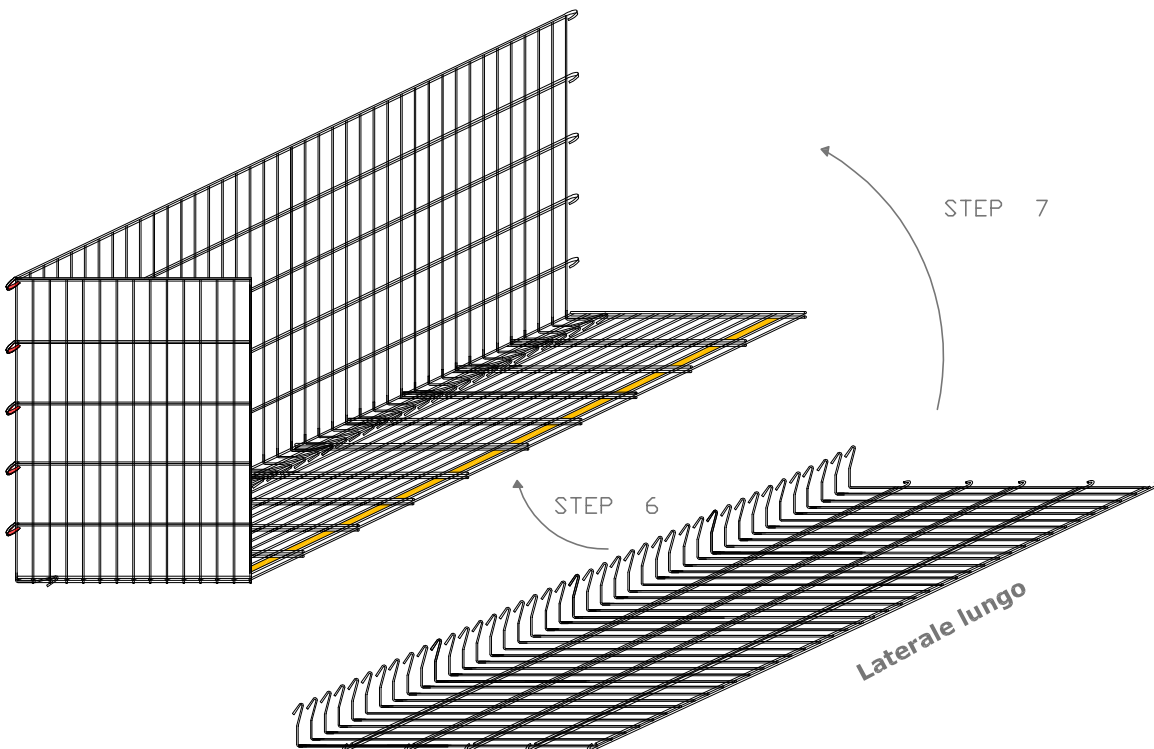

ISTRUZIONI DI MONTAGGIO

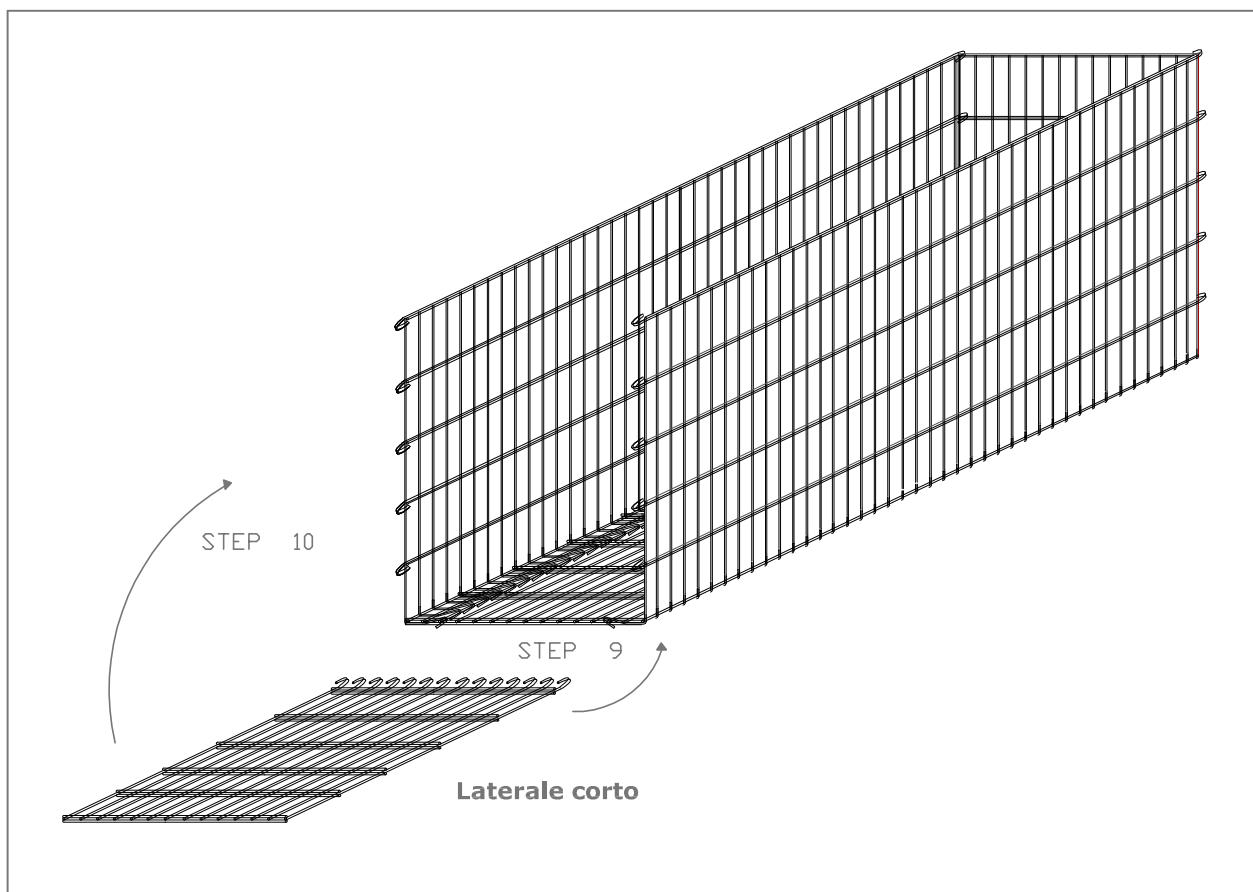
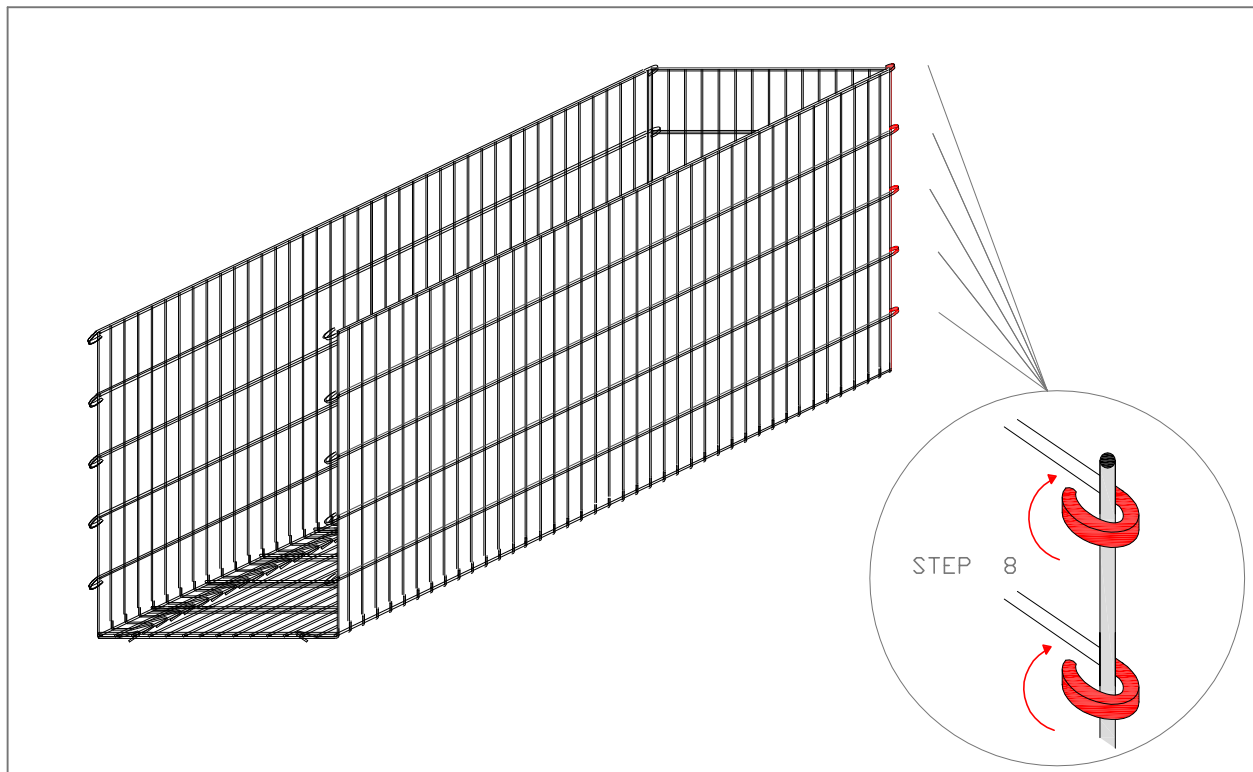

ISTRUZIONI DI MONTAGGIO



Gabbia con marcatura

PHONONIX

Con il sistema altamente
fono-assorbente

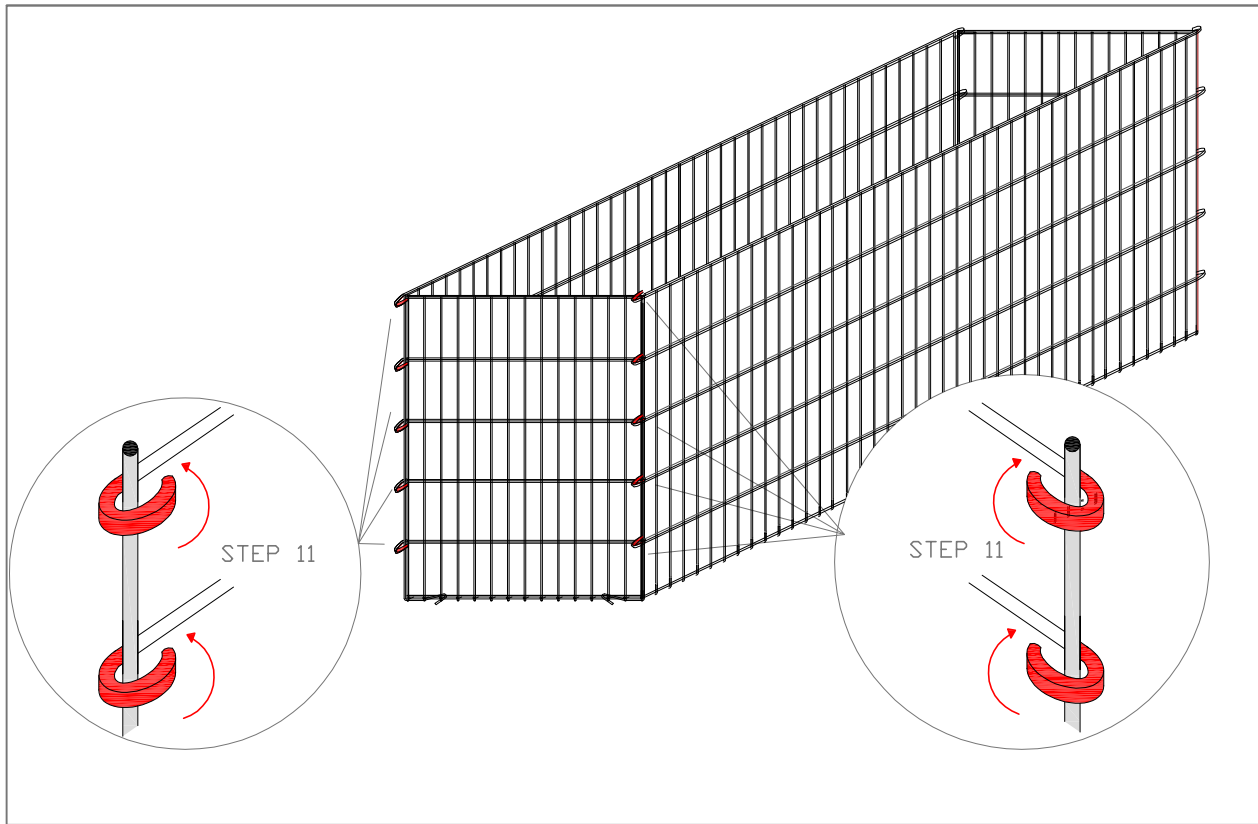

PATENT APPLIED

AGGANCIAMENTO DELLE PISTE DI SCORRIMENTO

STEP 12

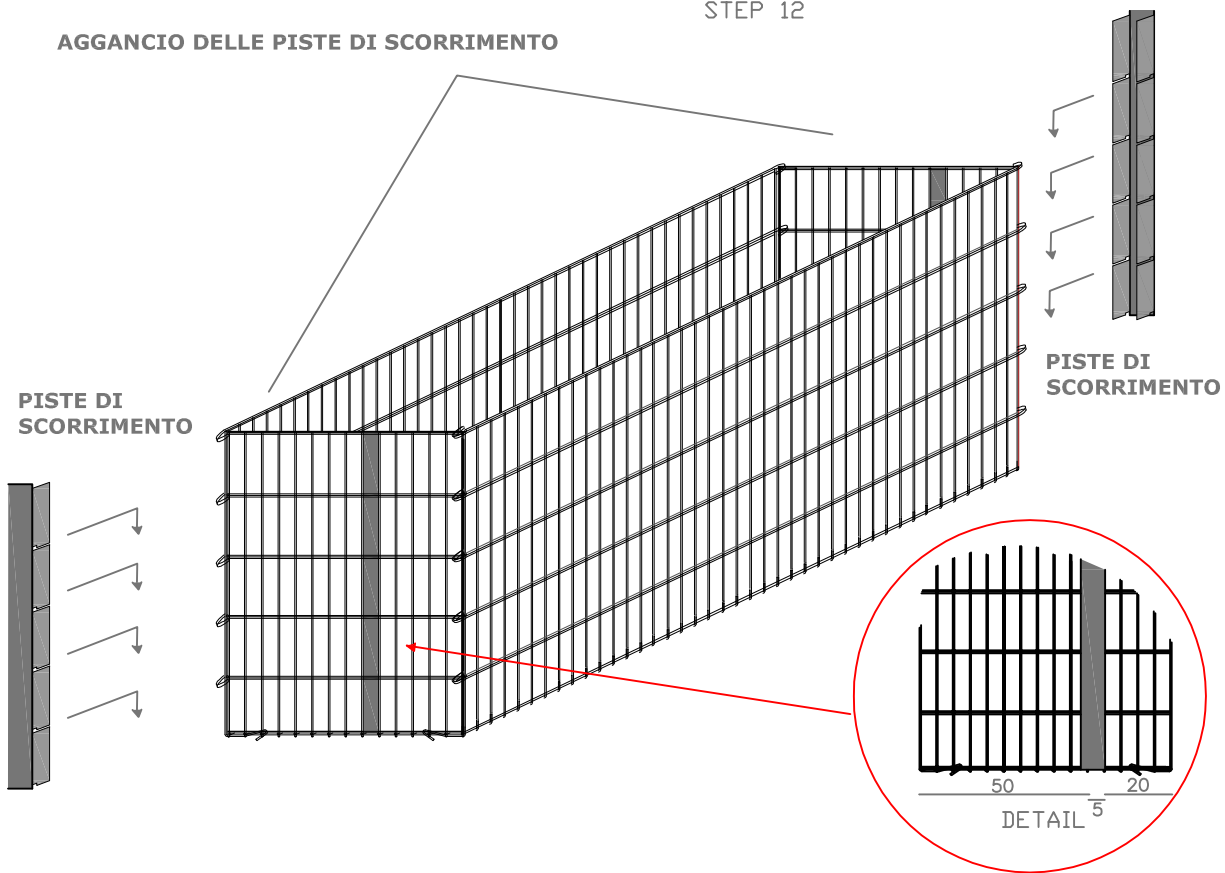

ISTRUZIONI DI MONTAGGIO

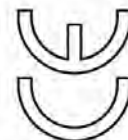

Gabbia con marcatura

PATENT APPLIED

STEP 13

INSERIRE LE LAME SCORREVOLI NELLE PISTE DI SCORRIMENTO PER FACILITARE L'INSERIMENTO DEL PANNELLO FONOASSORBENTE

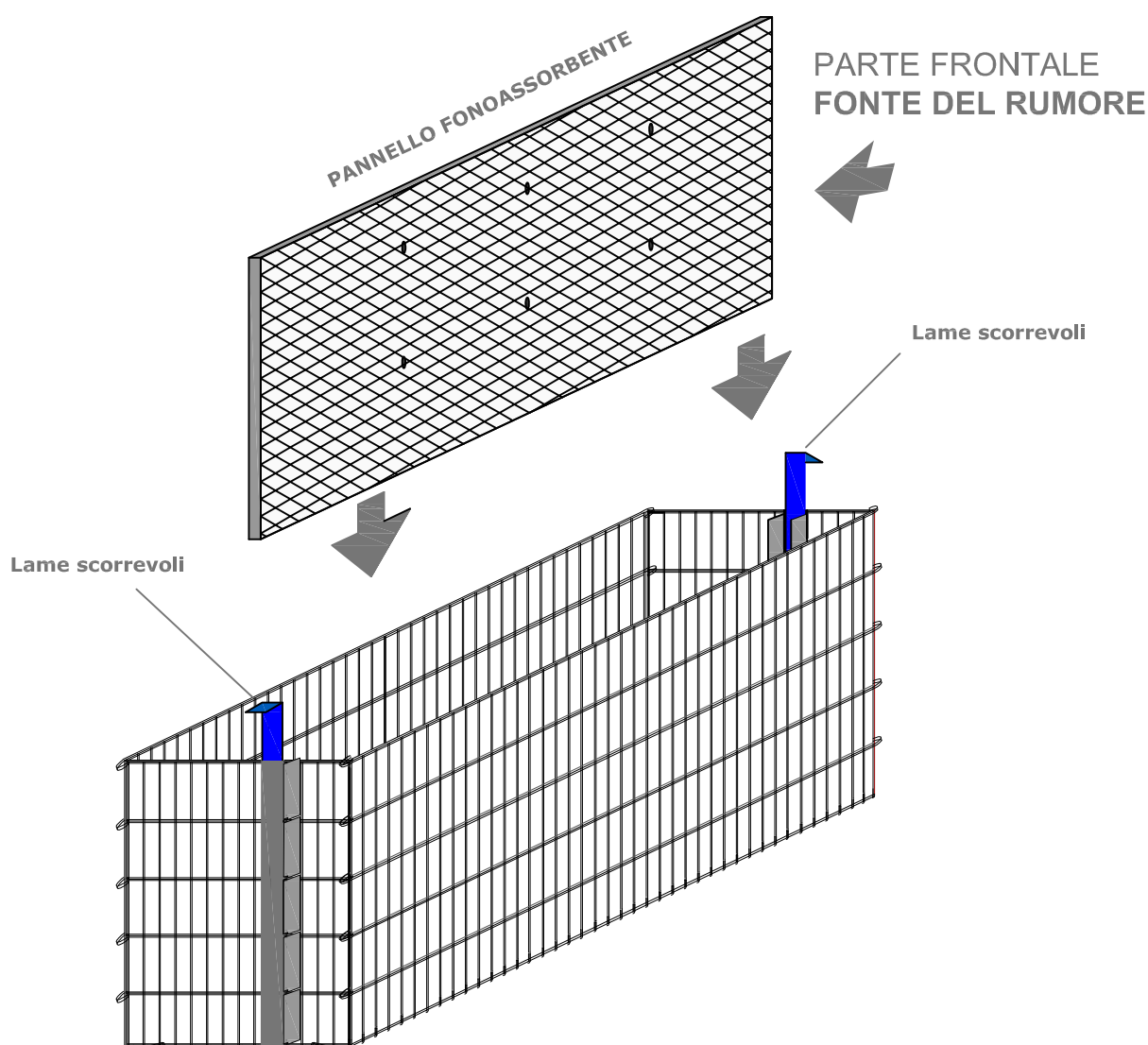

Rimuovere le lame scorrevoli dopo aver inserito il pannello fonoassorbente

Con il sistema altamente
fono-assorbente



PATENT APPLIED

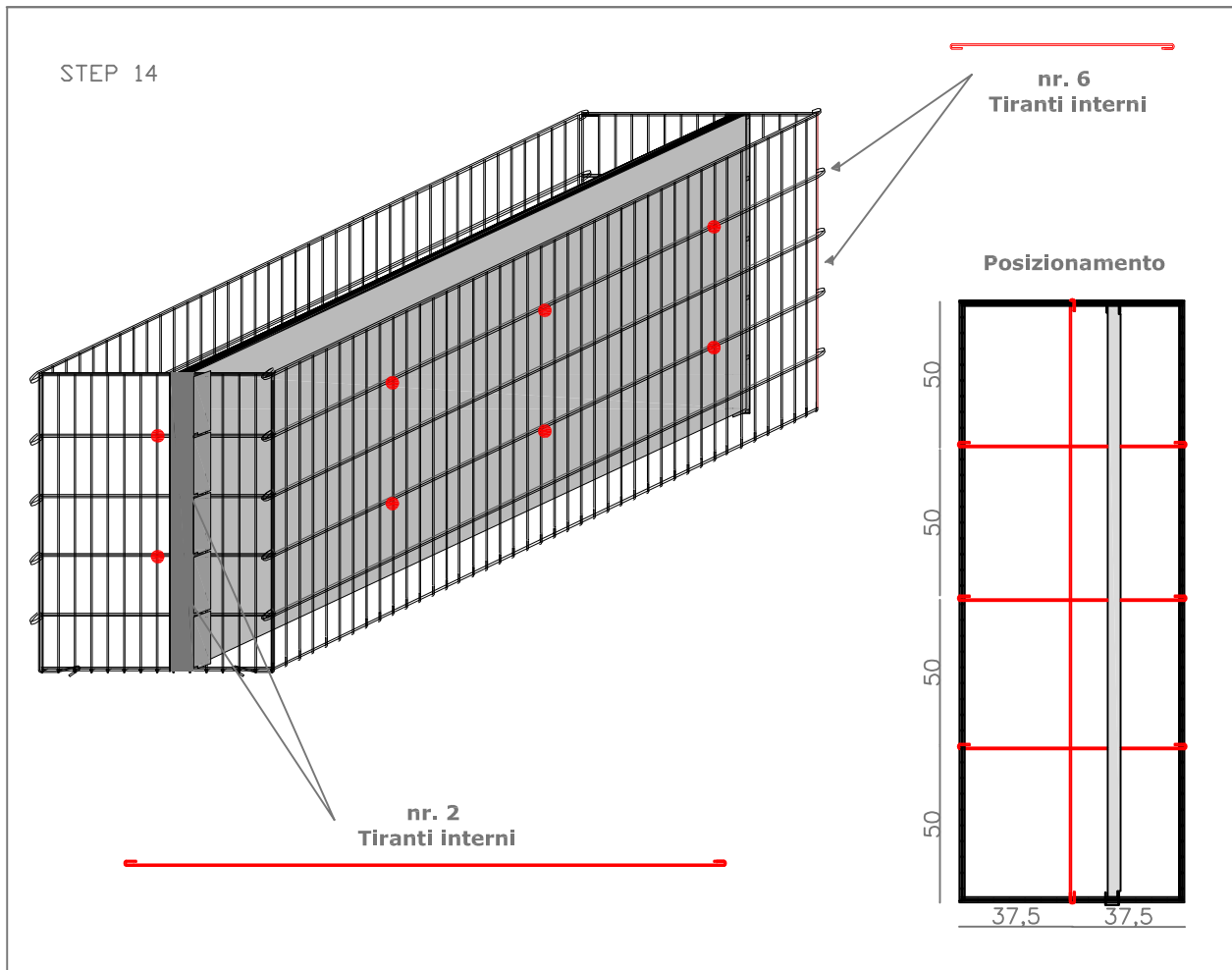

STEP

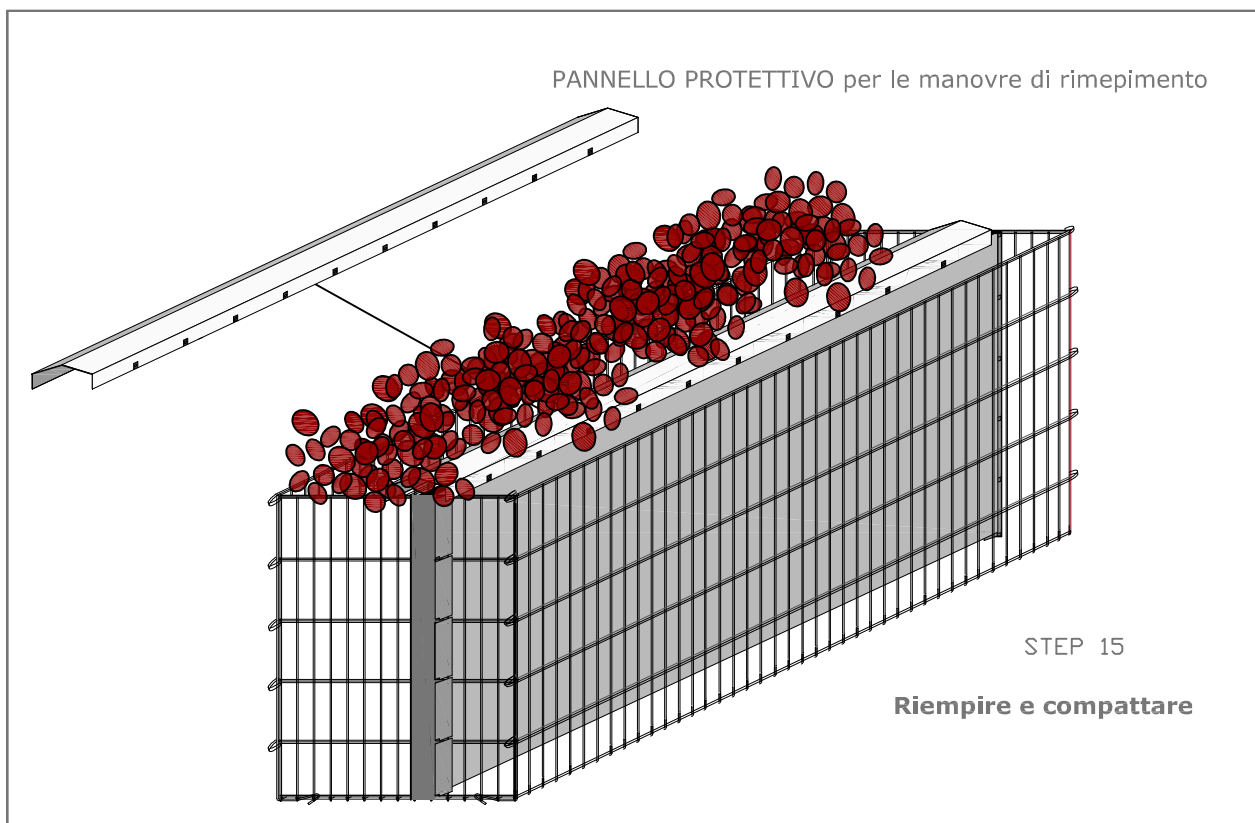

PATENT APPLIED

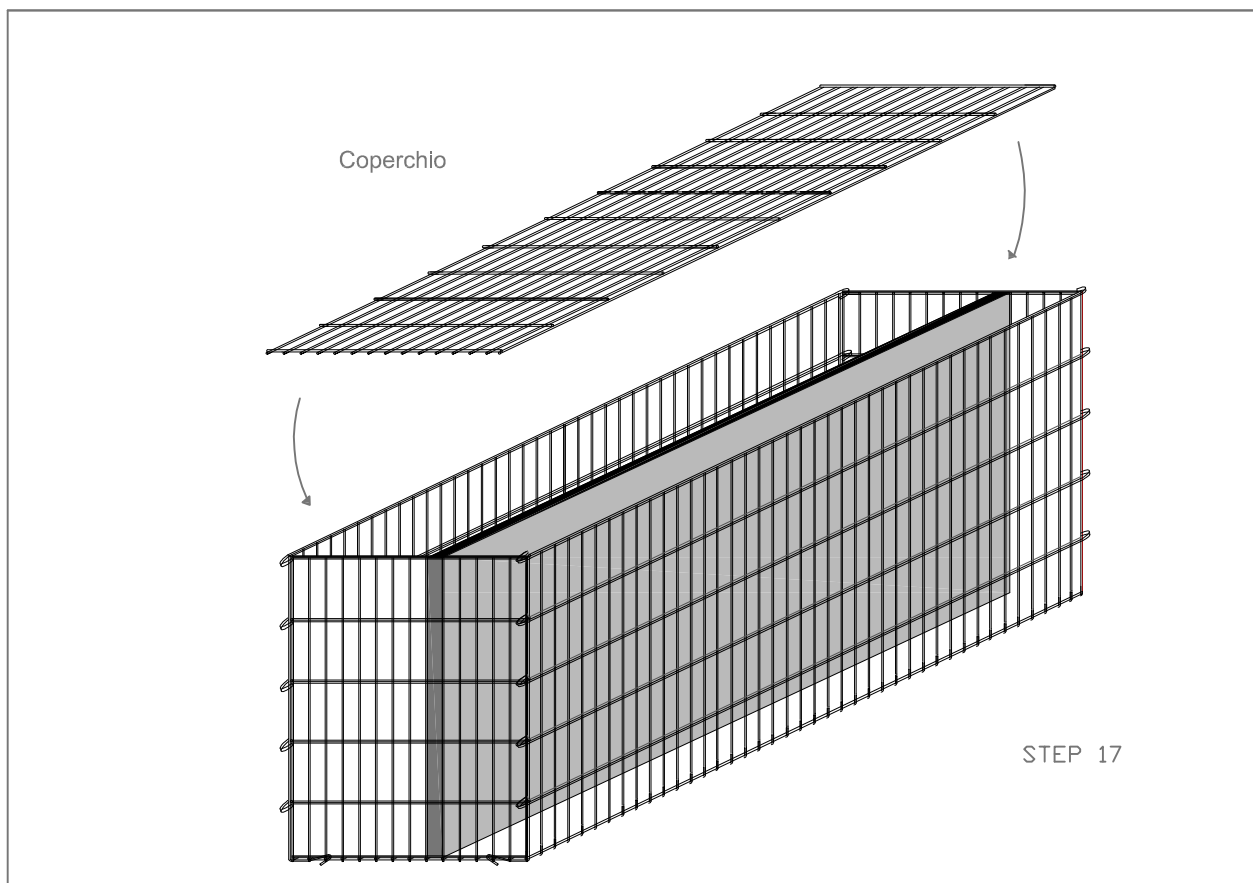
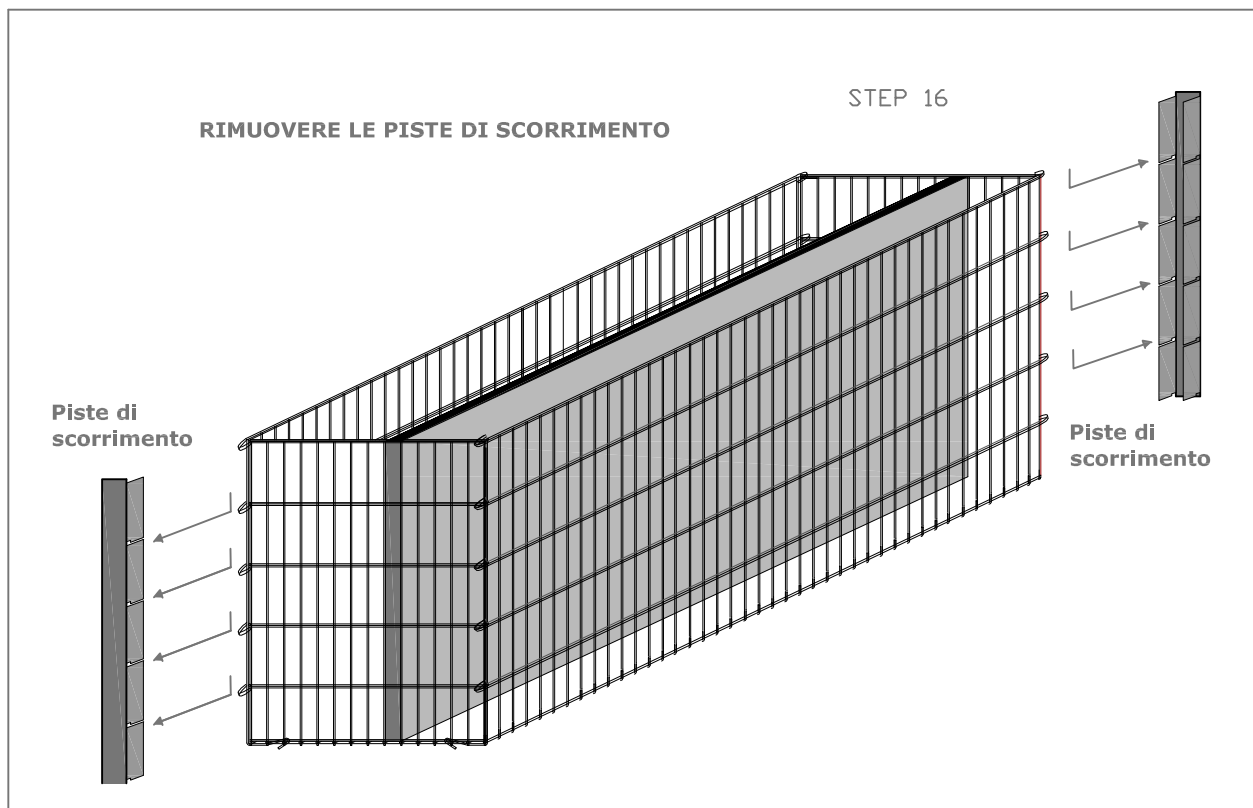

Gabbia con marcatura

PHONONIX

**Con il sistema altamente
fono-assorbente**



PATENT APPLIED

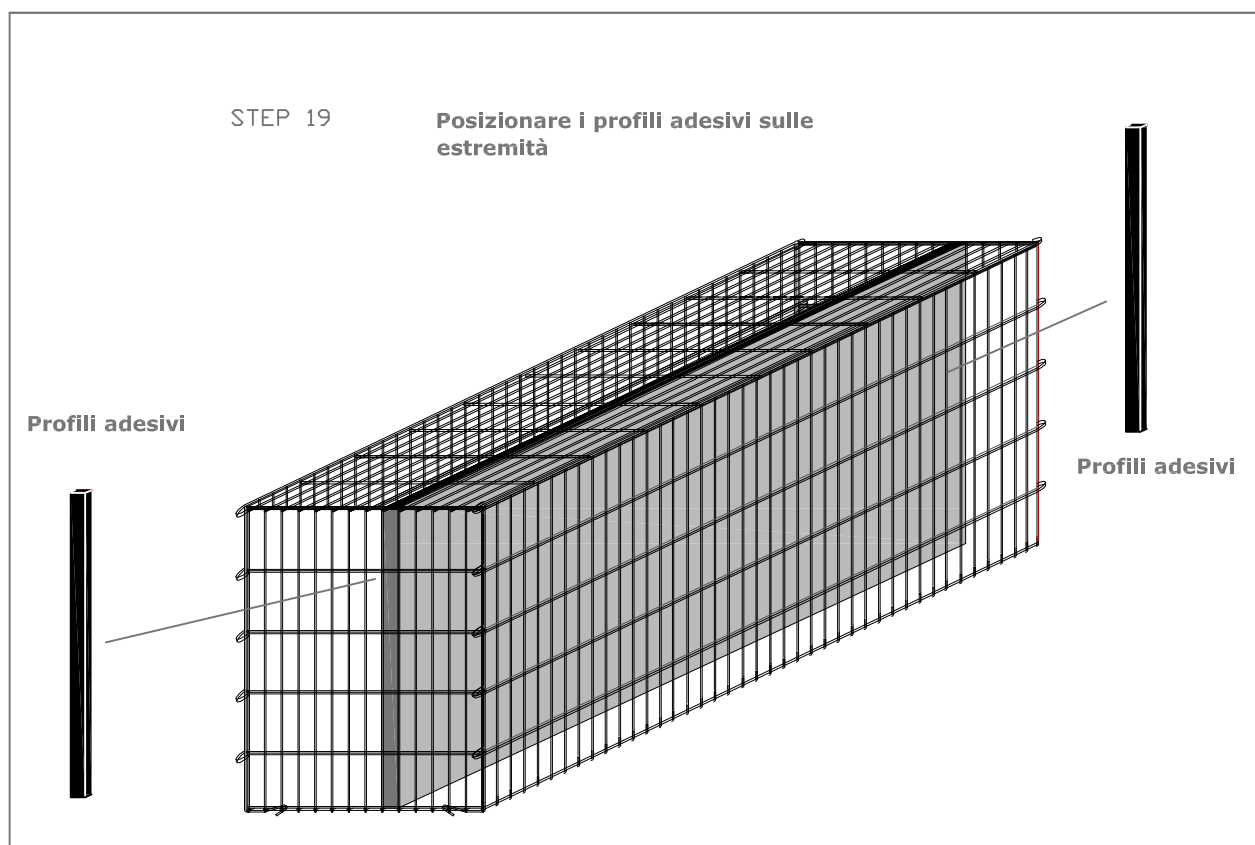
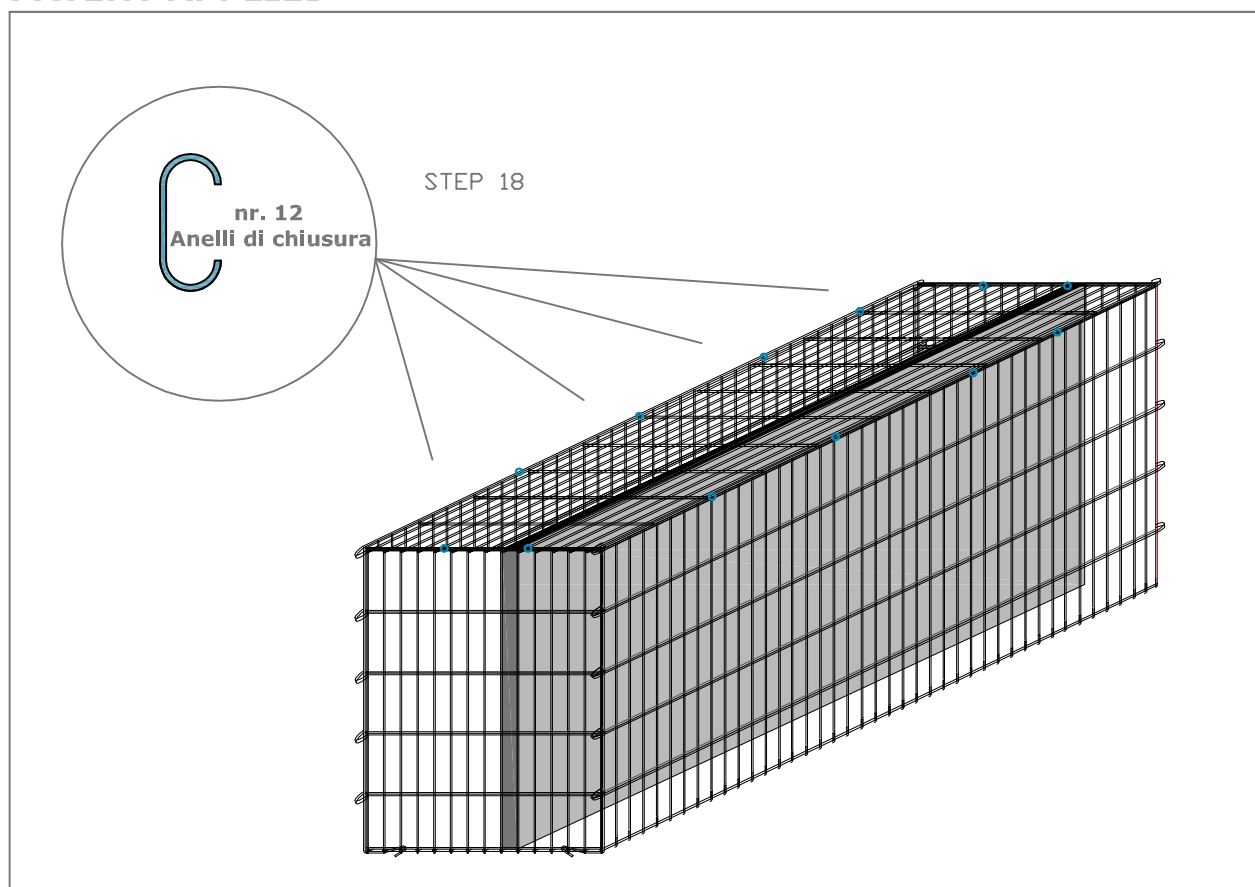

Gabbia con marcatura

PHONONIX

**Con il sistema altamente
fono-assorbente**



PATENT APPLIED

INSTALLAZIONE IN CANTIERE

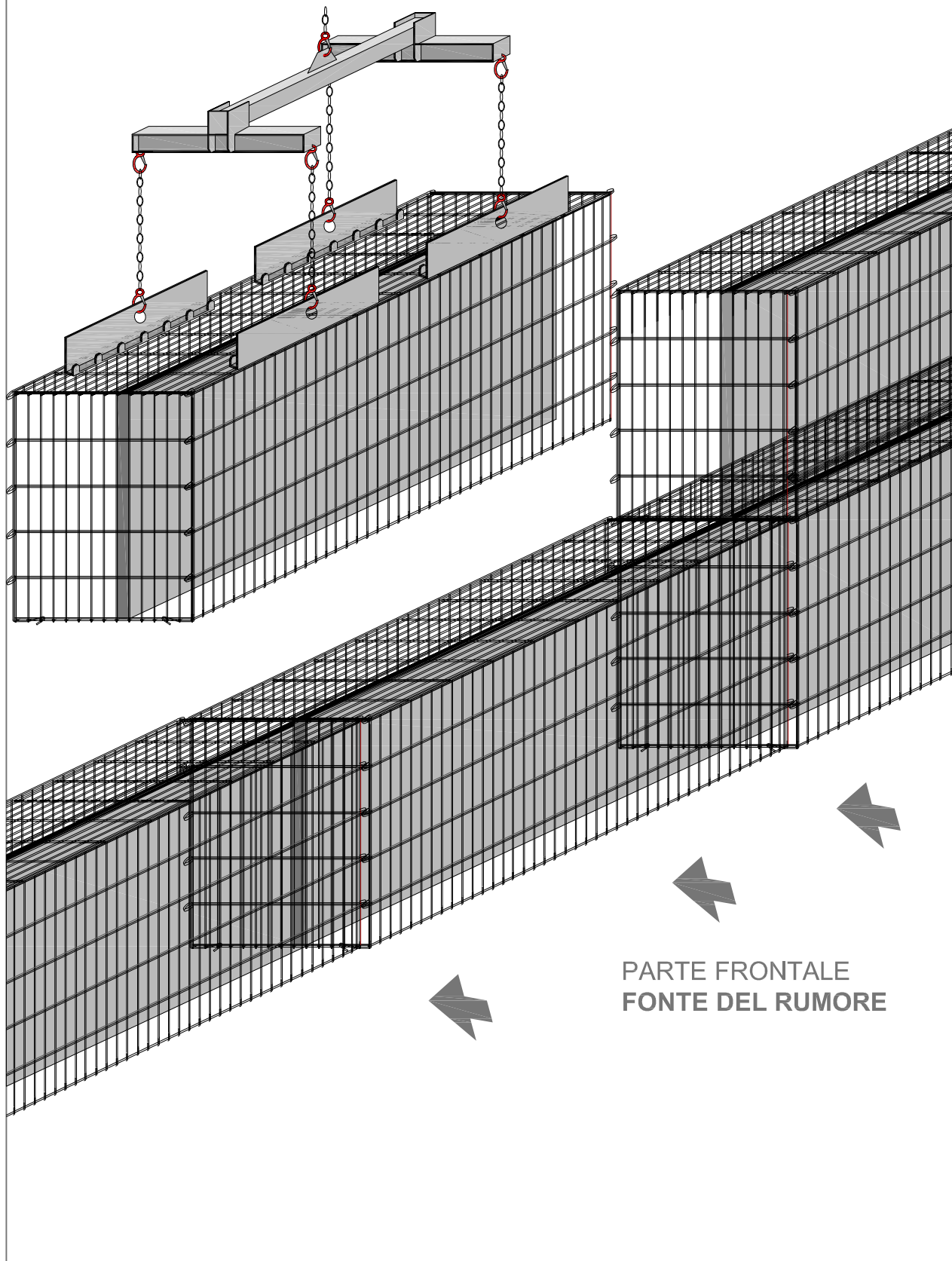

Con il sistema altamente
fono-assorbente **PHONONIX** Gabbia con marcatura

ACCESSORI per il SISTEMA FONOASSORBENTE

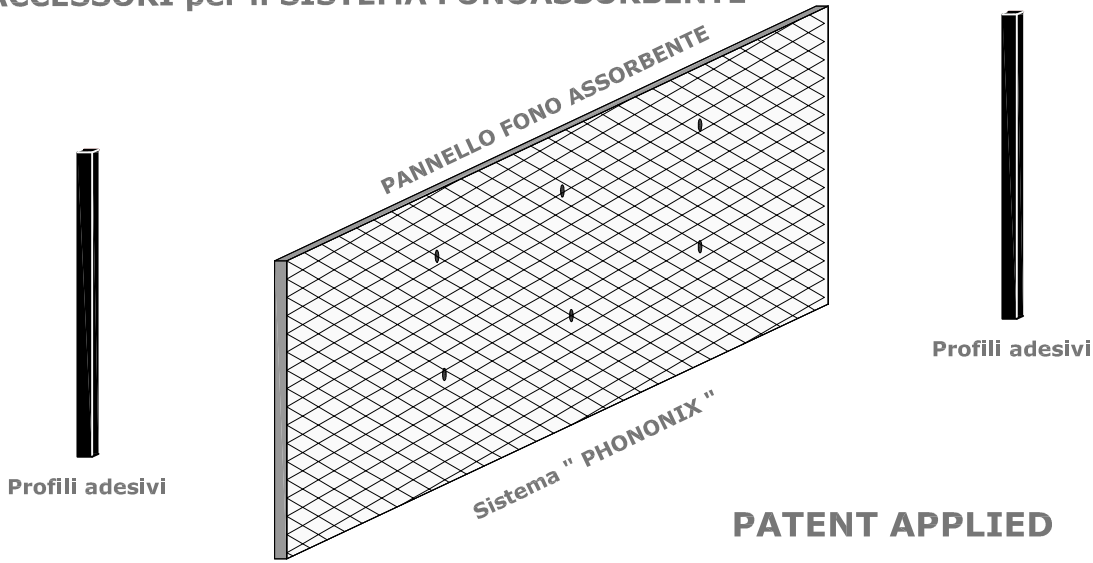

ACCESSORI per l'ASSEMBLAMENTO

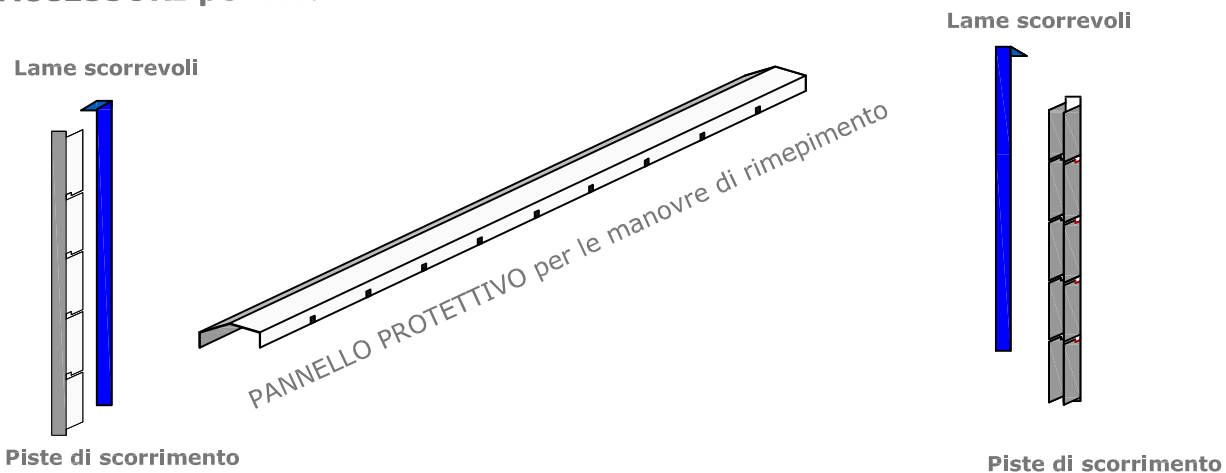

ACCESSORI per le manovre di SOLLEVAMENTO

TRAVERSA DI SOLLEVAMENTO AD H

PETTINI DI SOLLEVAMENTO LSB

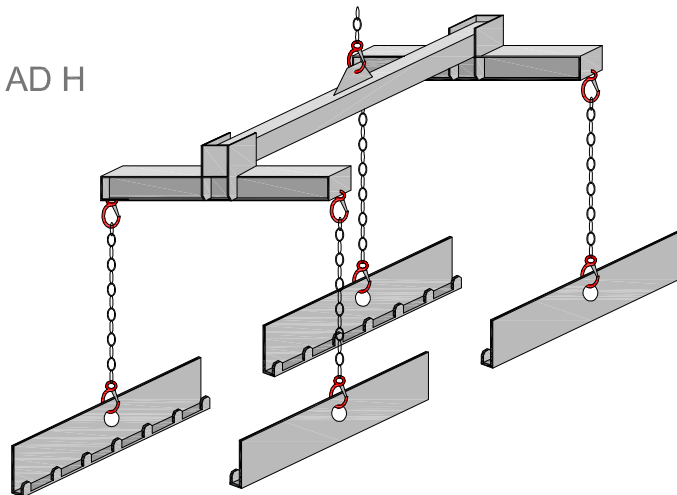

Gabbia con marcatura

PHONONIX

Con il sistema altamente
fono-assorbente

