

ISTRUZIONI DI MONTAGGIO

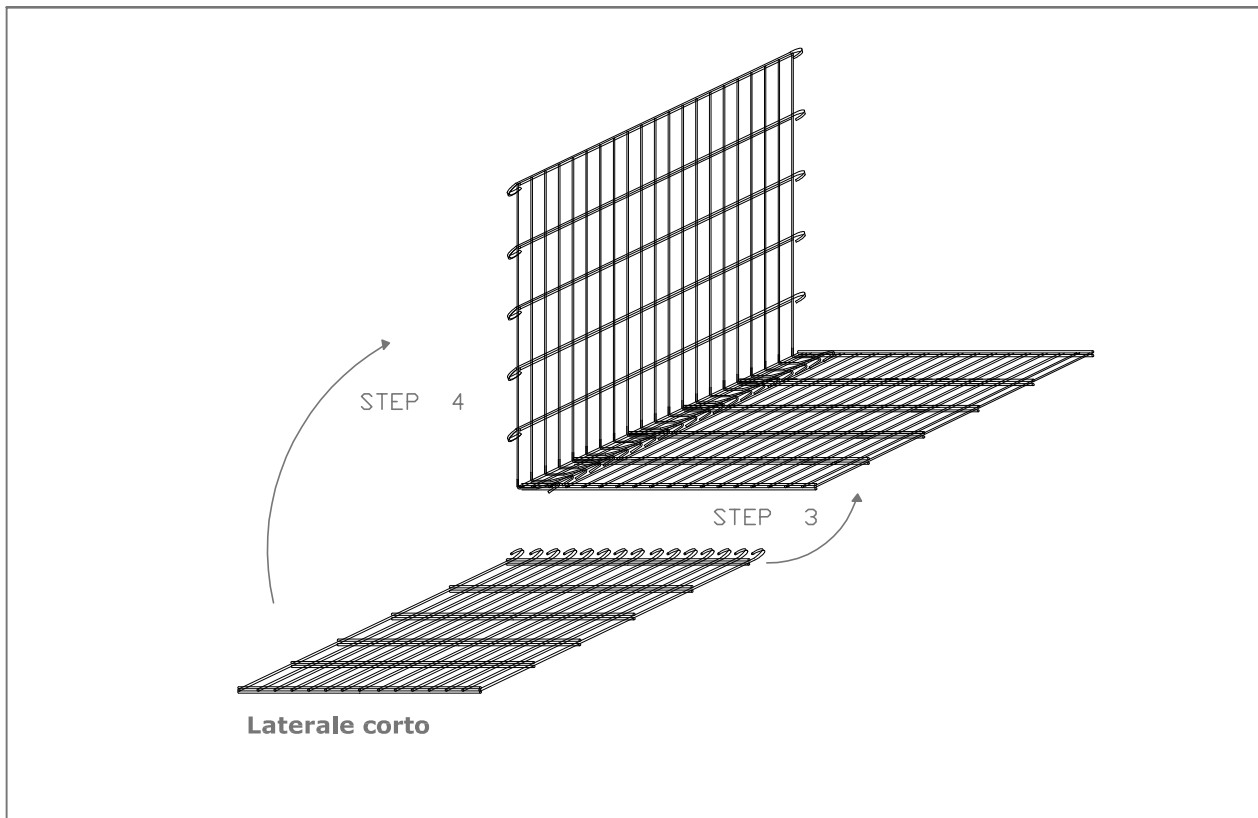
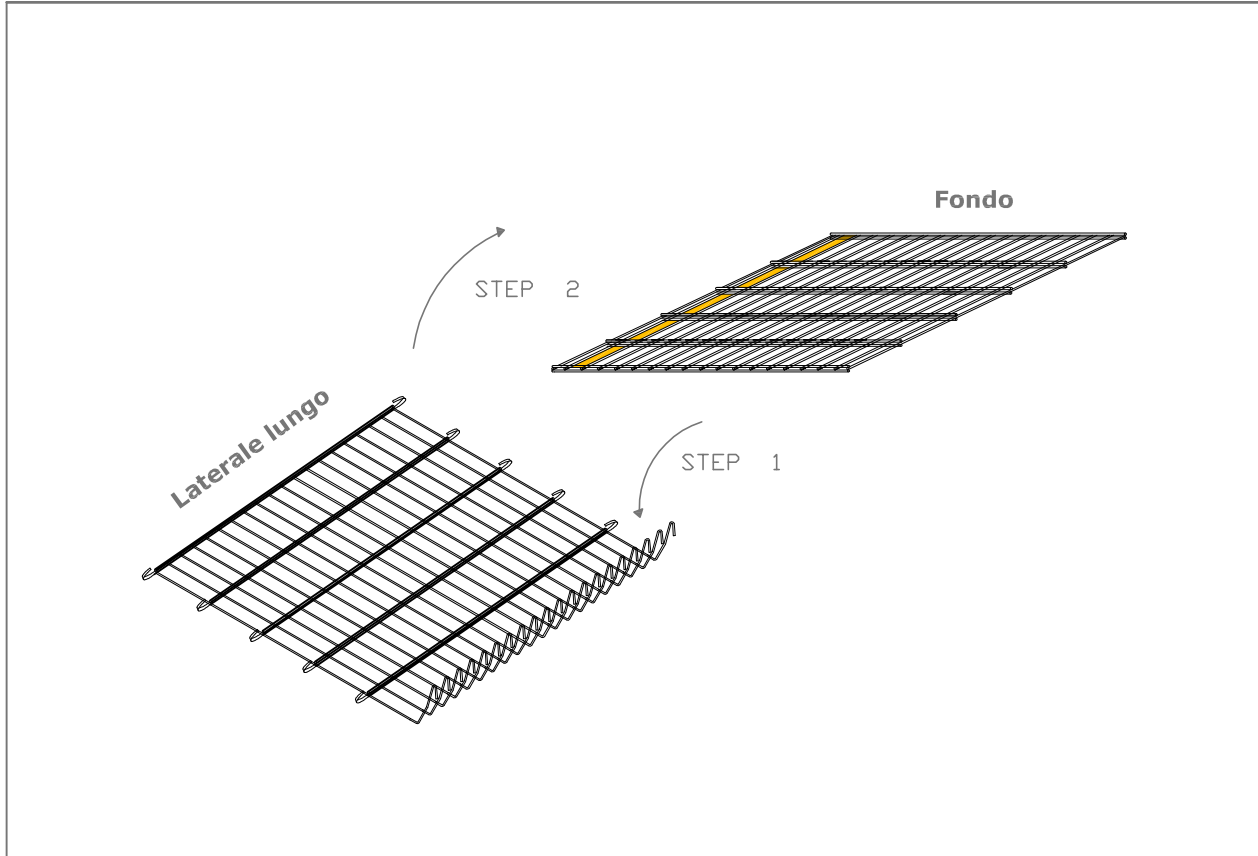

Gabbia con marcatura

PHONONIX

Con il sistema altamente
fono-assorbente



ISTRUZIONI DI MONTAGGIO

Gabbia con marcatura

PHONONIX

**Con il sistema altamente
fono-assorbente**

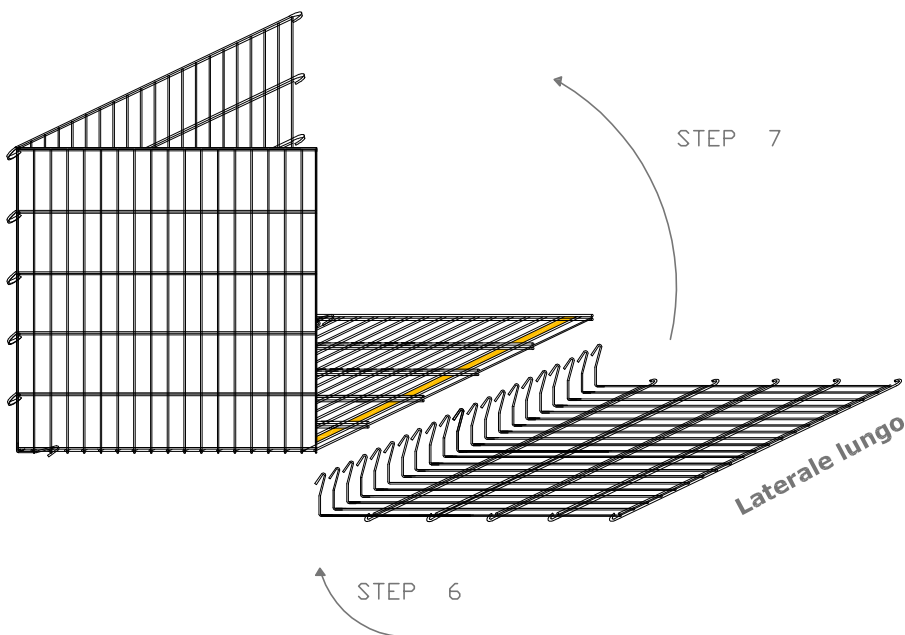
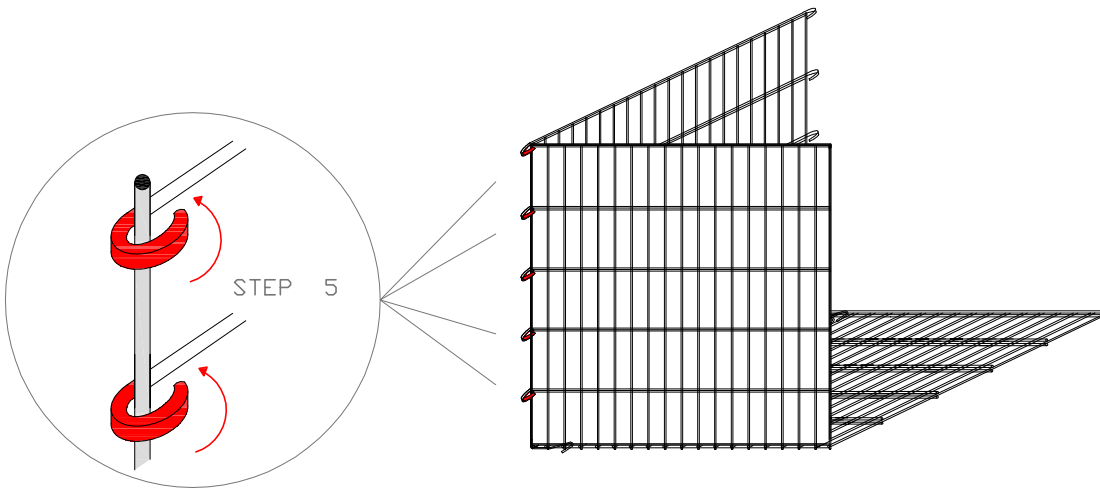

ISTRUZIONI DI MONTAGGIO

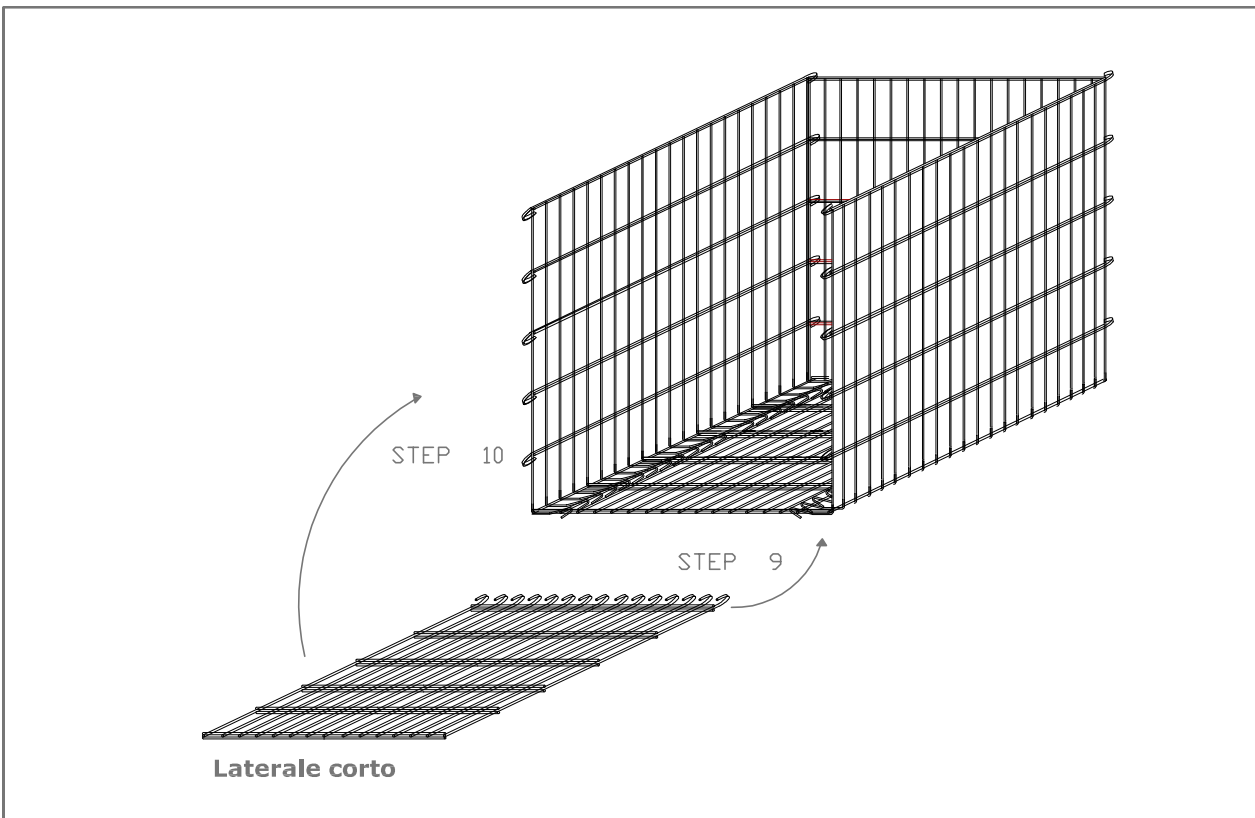
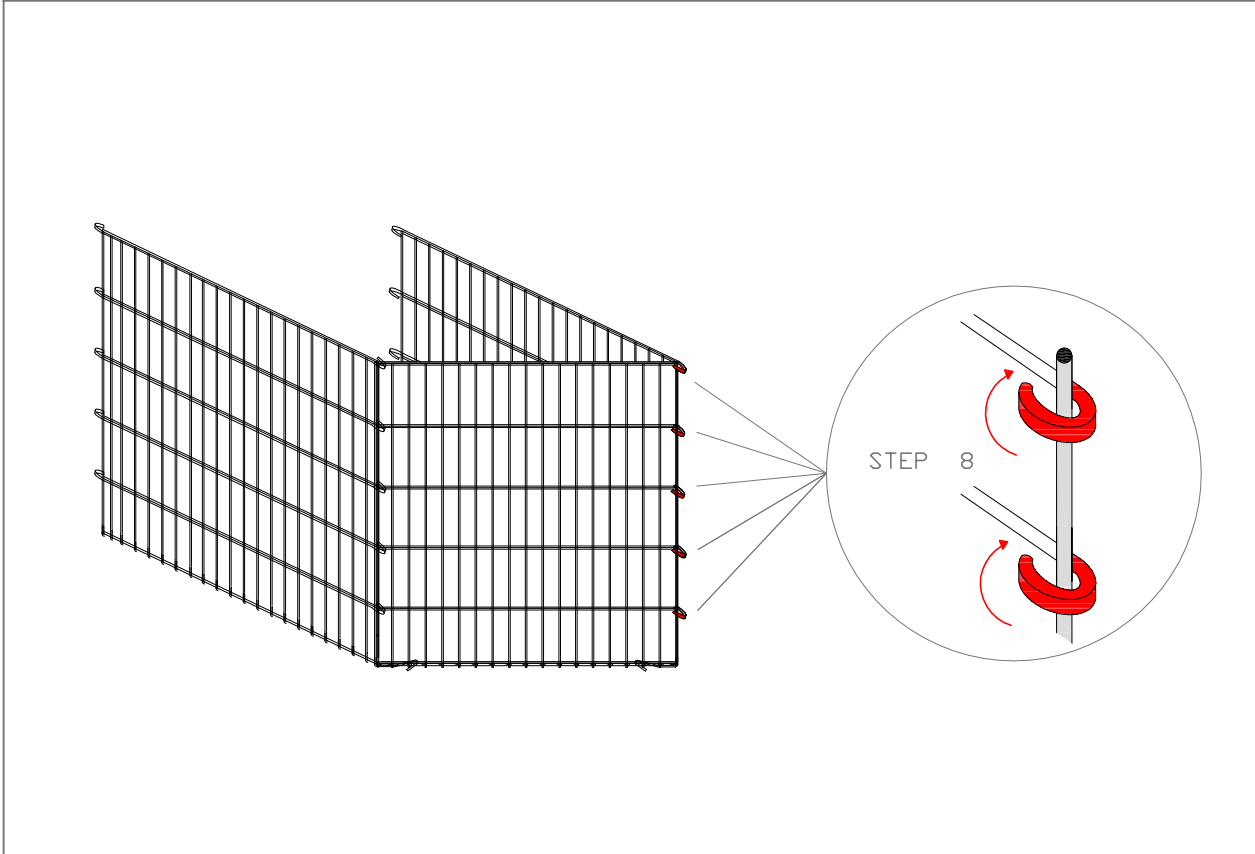

Gabbia con marcatura

PHONONIX

Con il sistema altamente
fono-assorbente



ISTRUZIONI DI MONTAGGIO

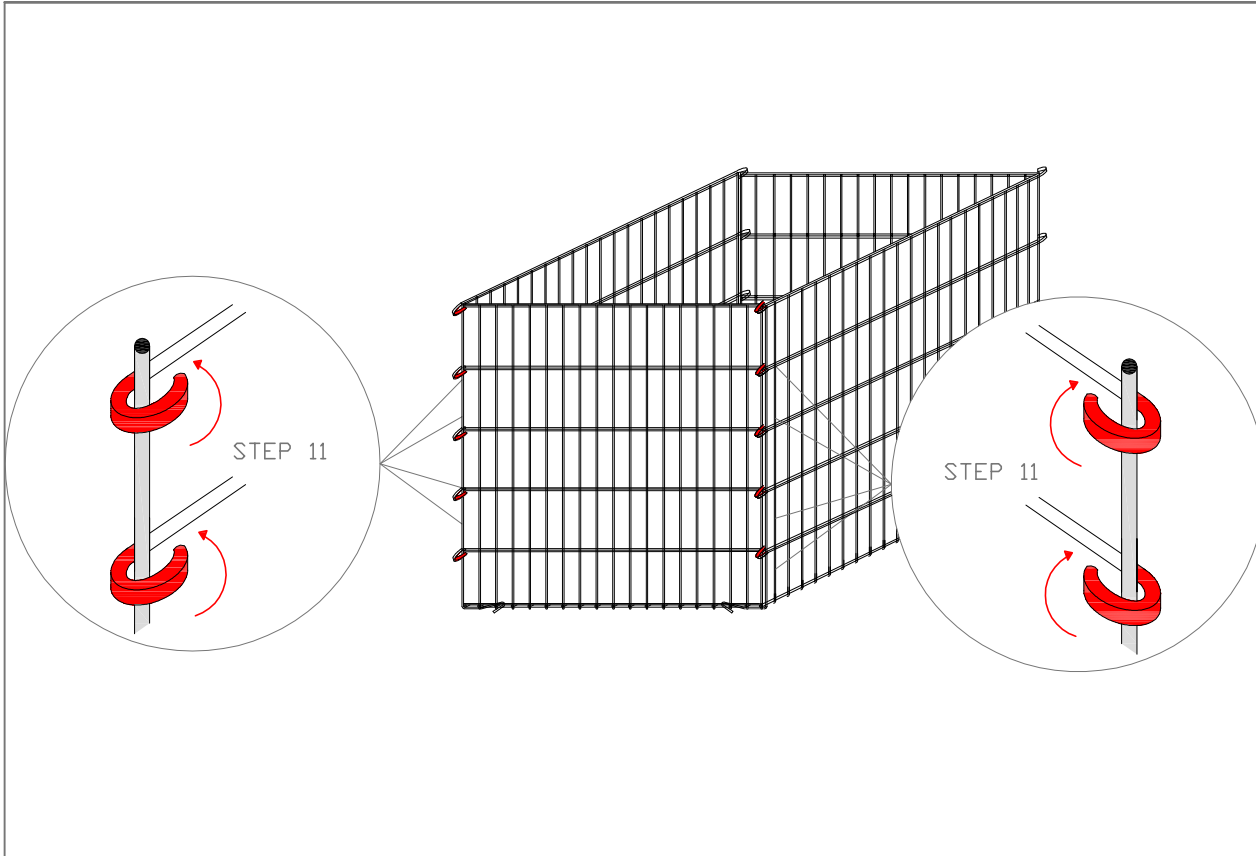

PATENT APPLIED

AGGANCIO DELLE PISTE DI SCORRIMENTO

PISTE DI SCORRIMENTO

STEP 12

PISTE DI SCORRIMENTO

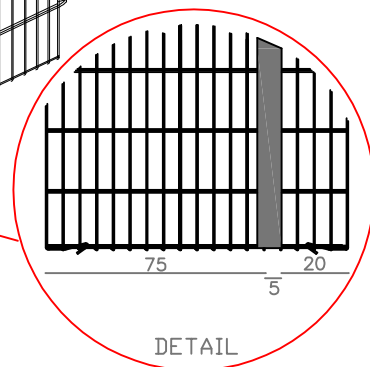
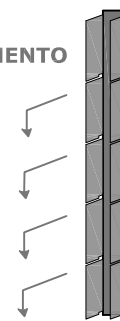
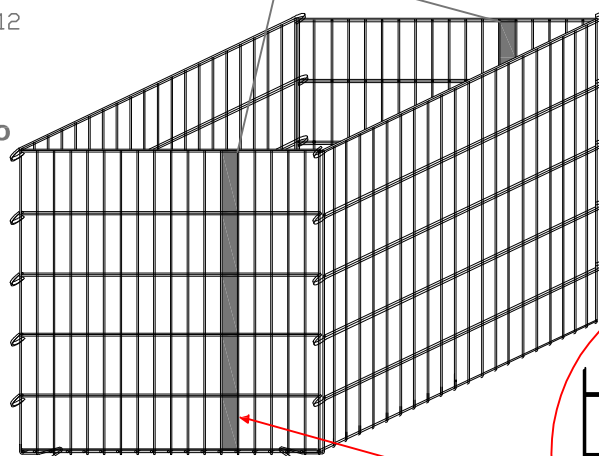
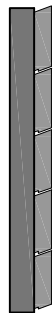

ISTRUZIONI DI MONTAGGIO

STEP 13

INSERIRE LE LAME SCORREVOLI NELLE PISTE DI SCORRIMENTO PER FACILITARE L'INSERIMENTO DEL PANNELLO FONOASSORBENTE

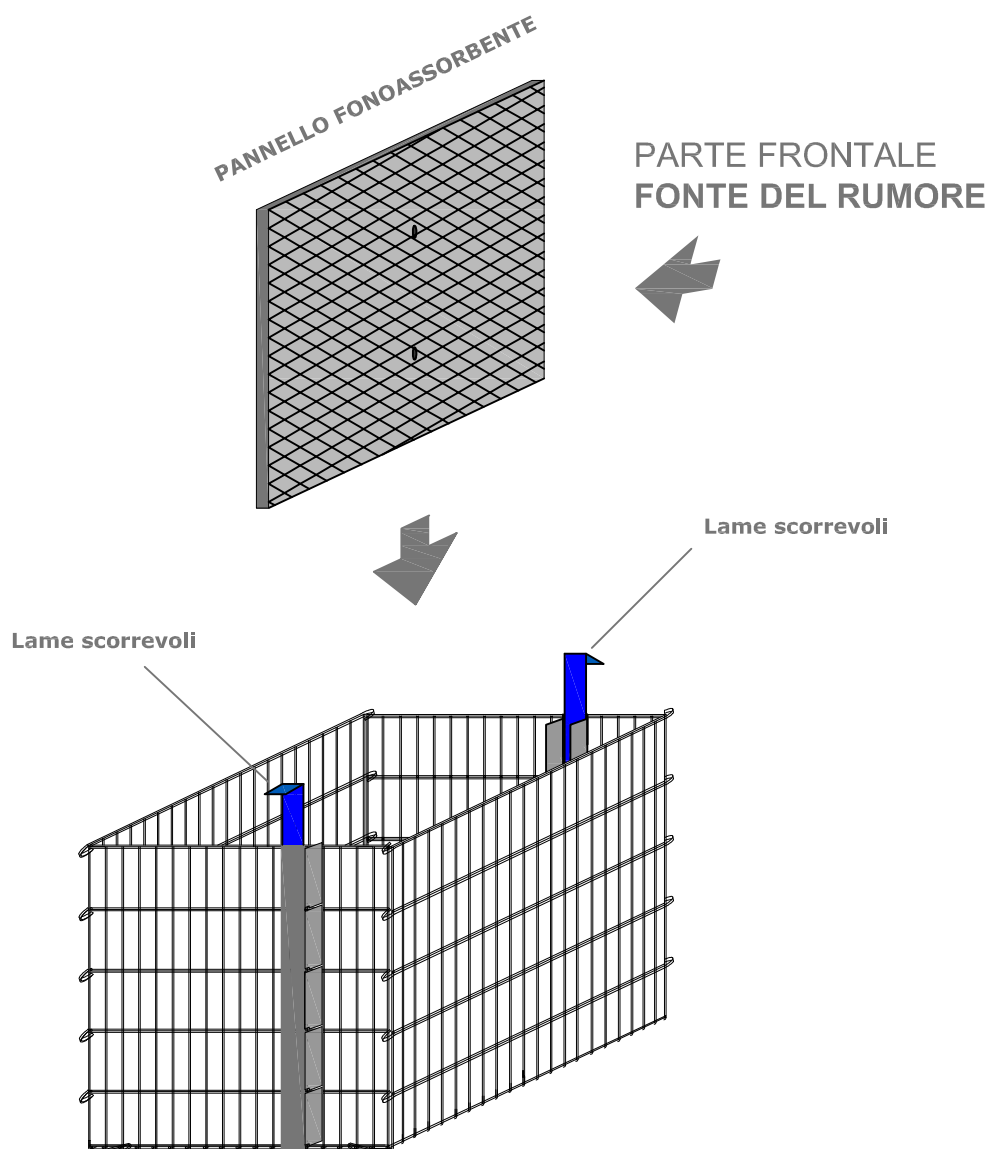

Rimuovere le lame scorrevoli dopo aver inserito il pannello fonoassorbente

PATENT APPLIED

Gabbia con marcatura

STEP 14

Nr. 4 Tiranti interni

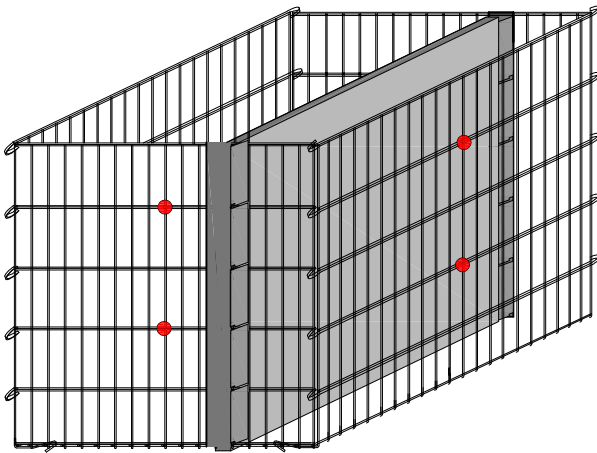

Posizionamento

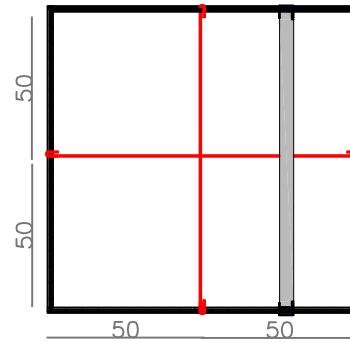

PANNELLO PROTETTIVO per le manovre di riempimento

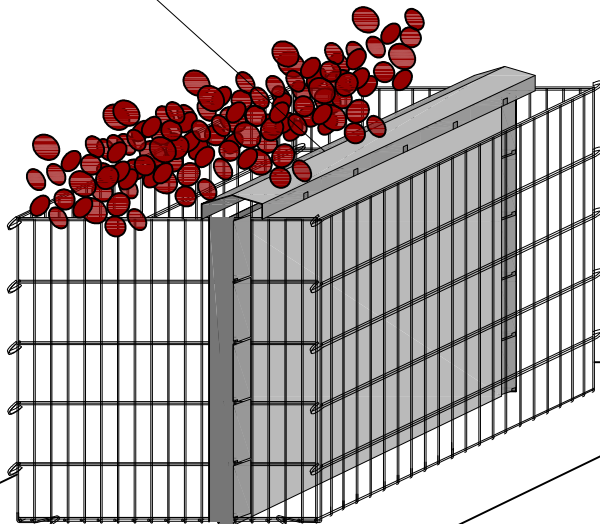
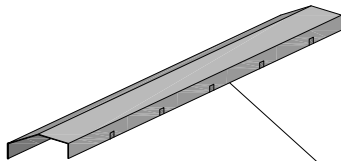

STEP 15

Riempire e compattare

PHONONIX

**Con il sistema altamente
fono-assorbente**

PATENT APPLIED

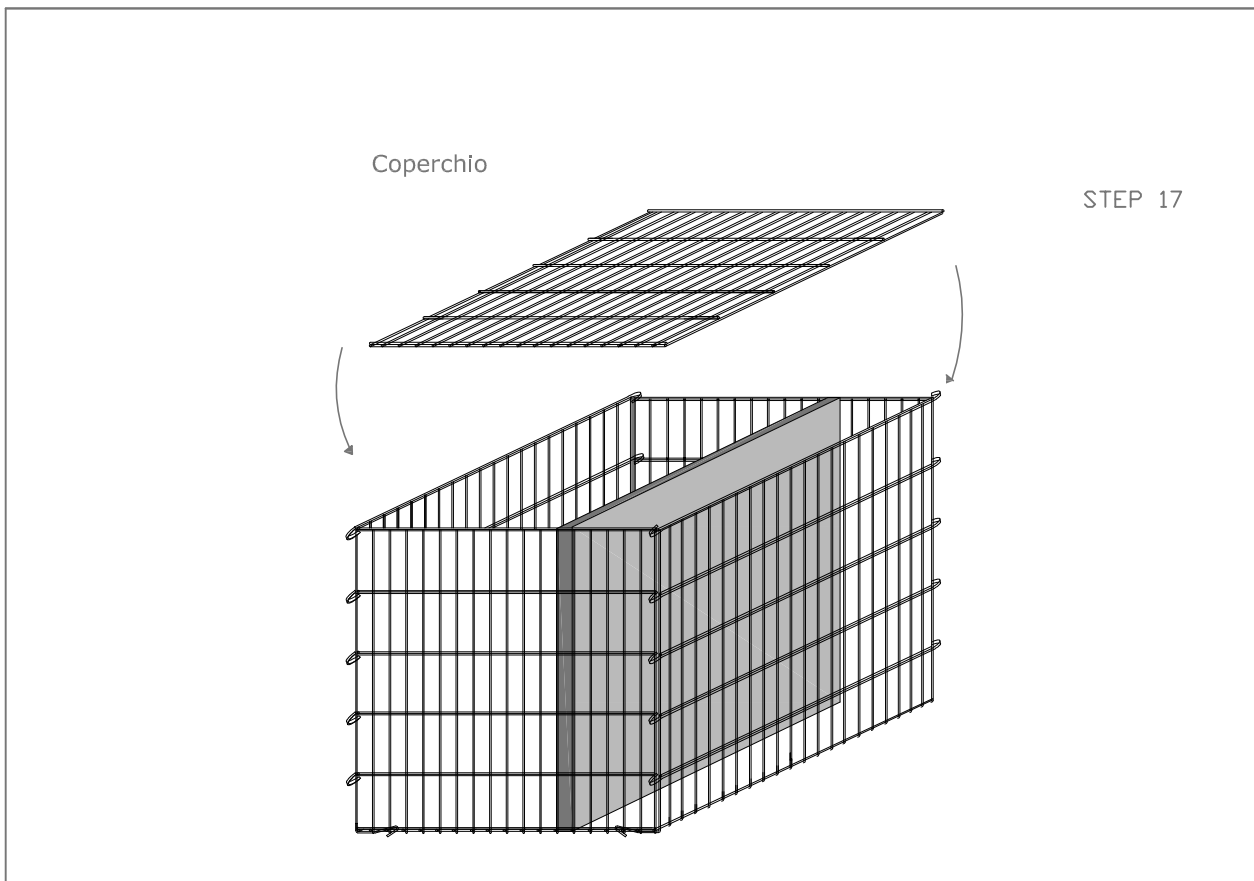
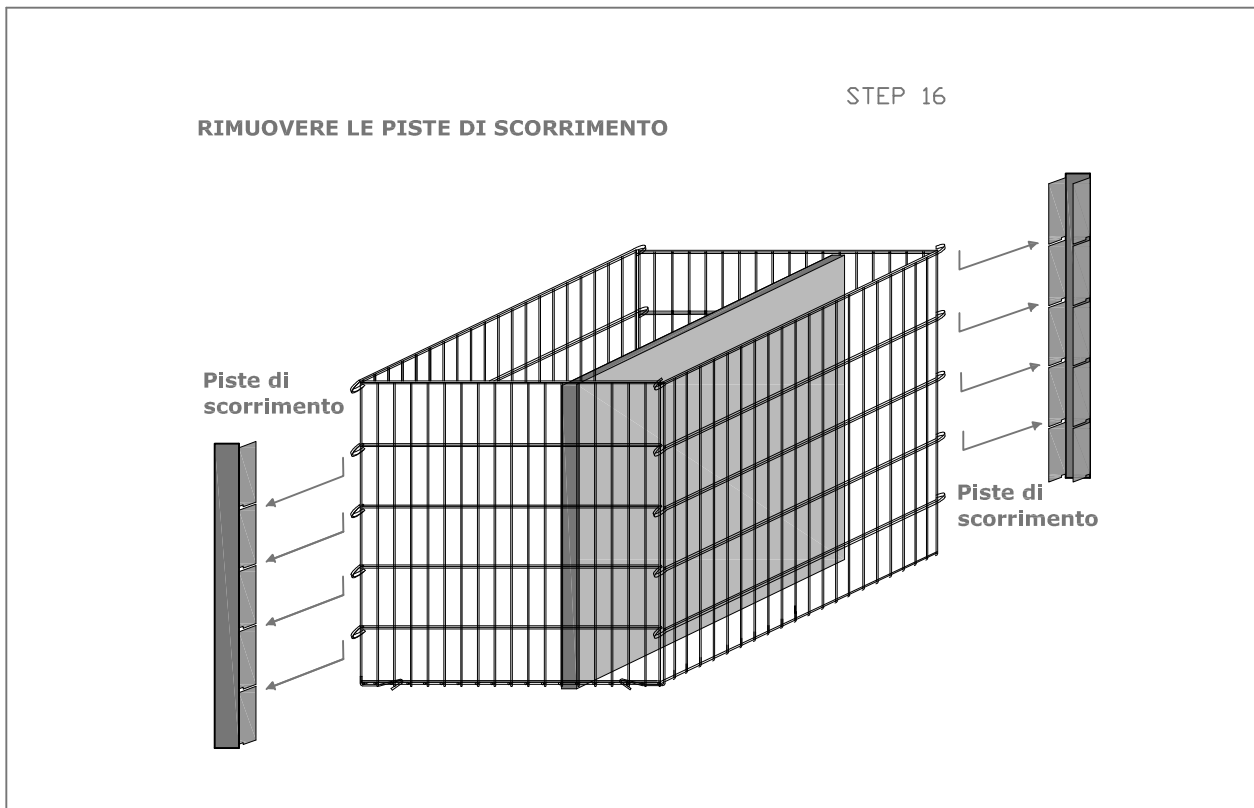

PATENT APPLIED

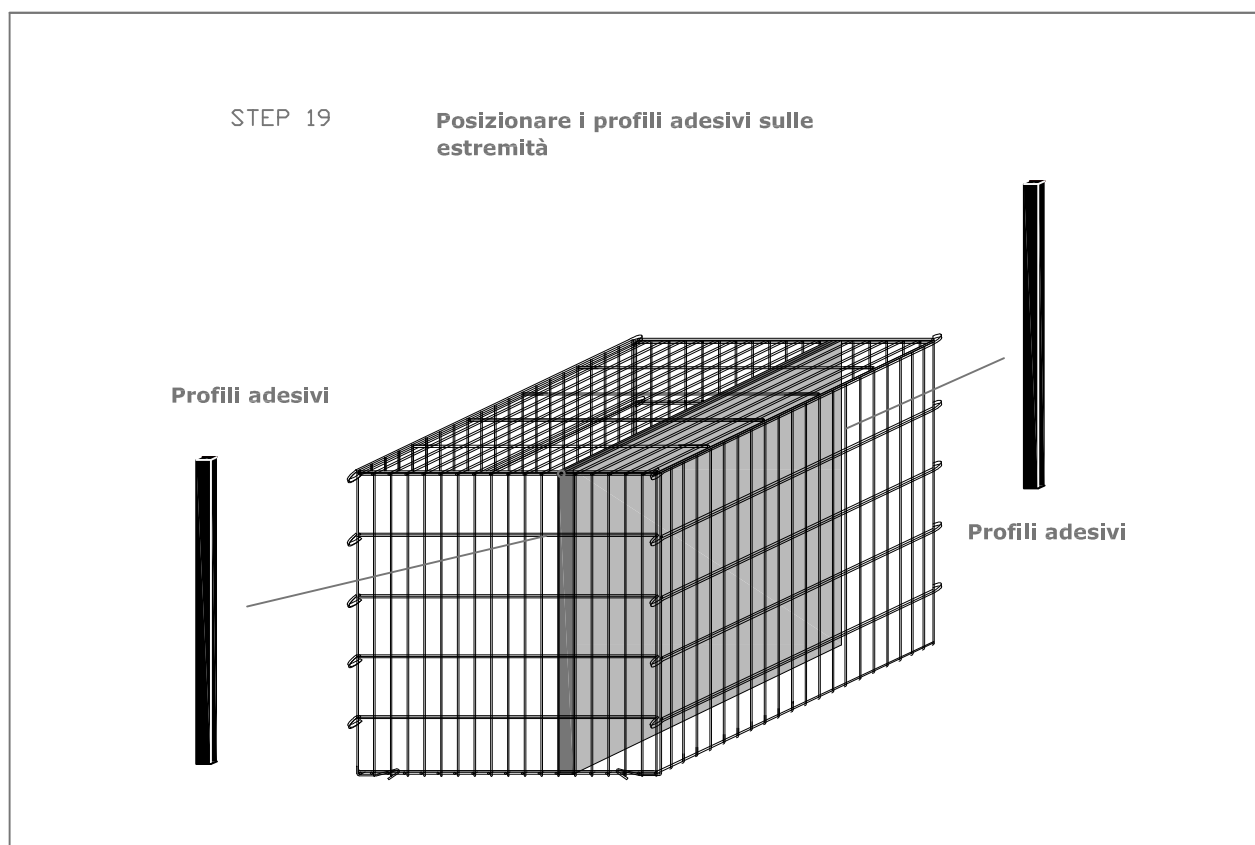
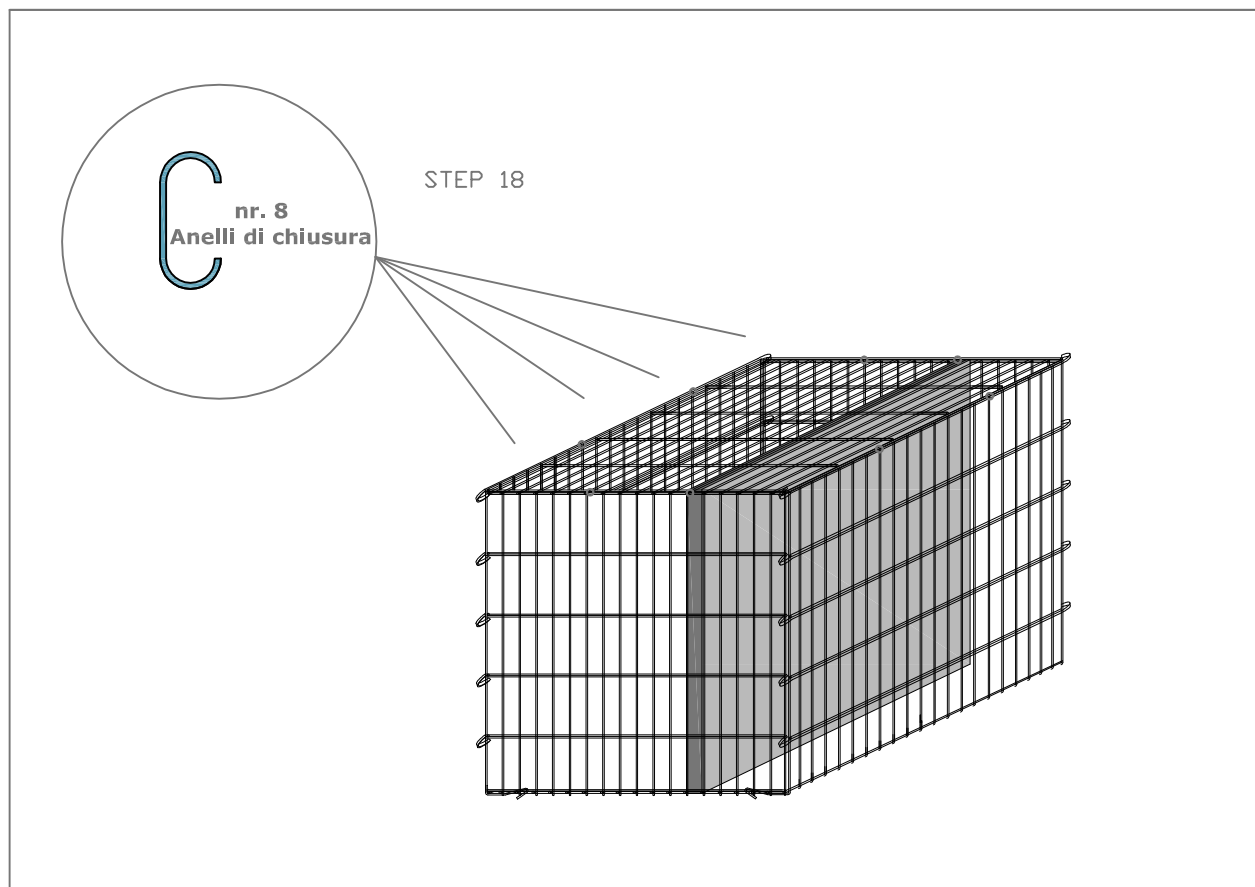

PATENT APPLIED

INSTALLAZIONE IN CANTIERE

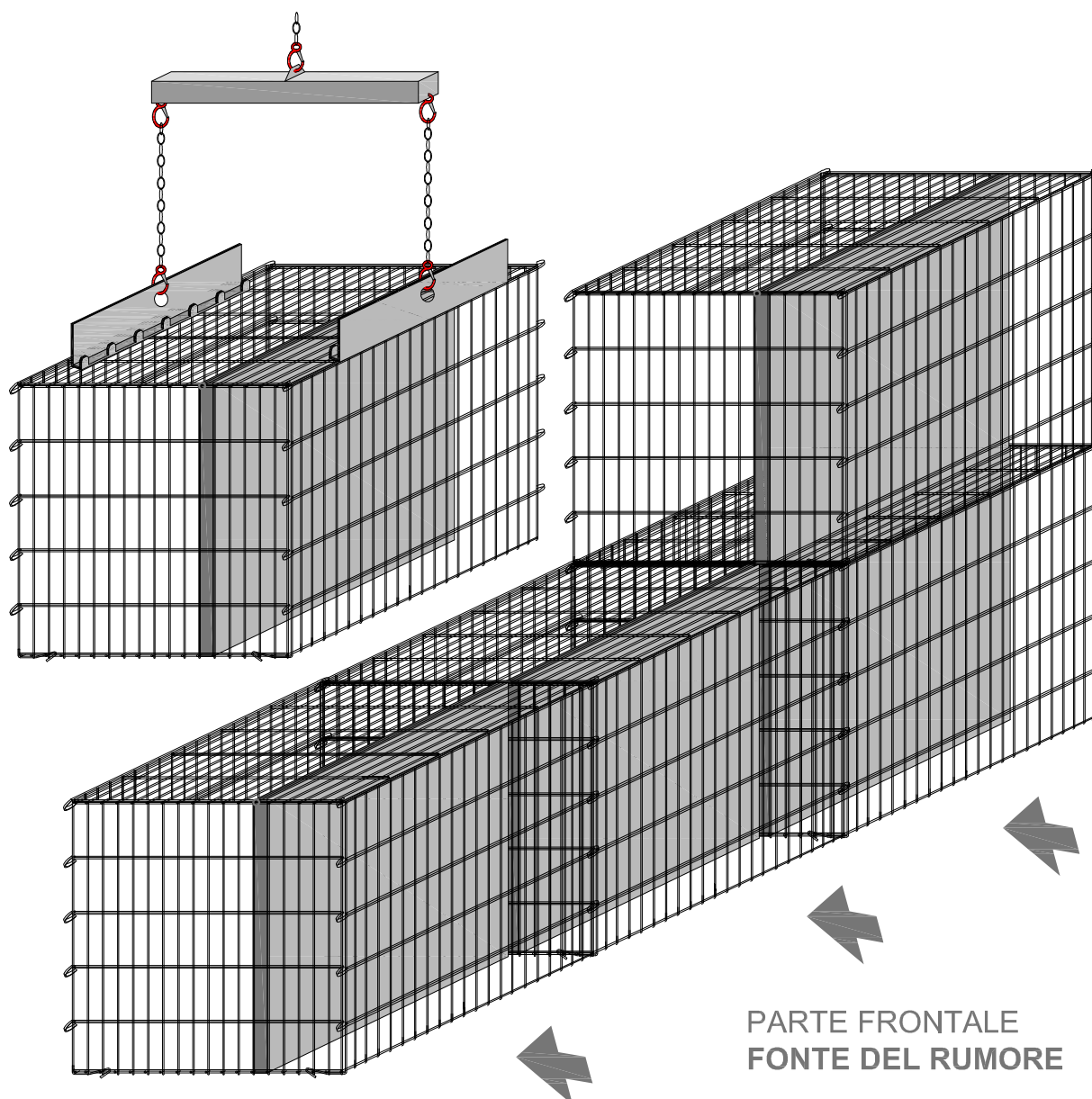

Gabbia con marcatura

PHONONIX

Con il sistema altamente
fono-assorbente

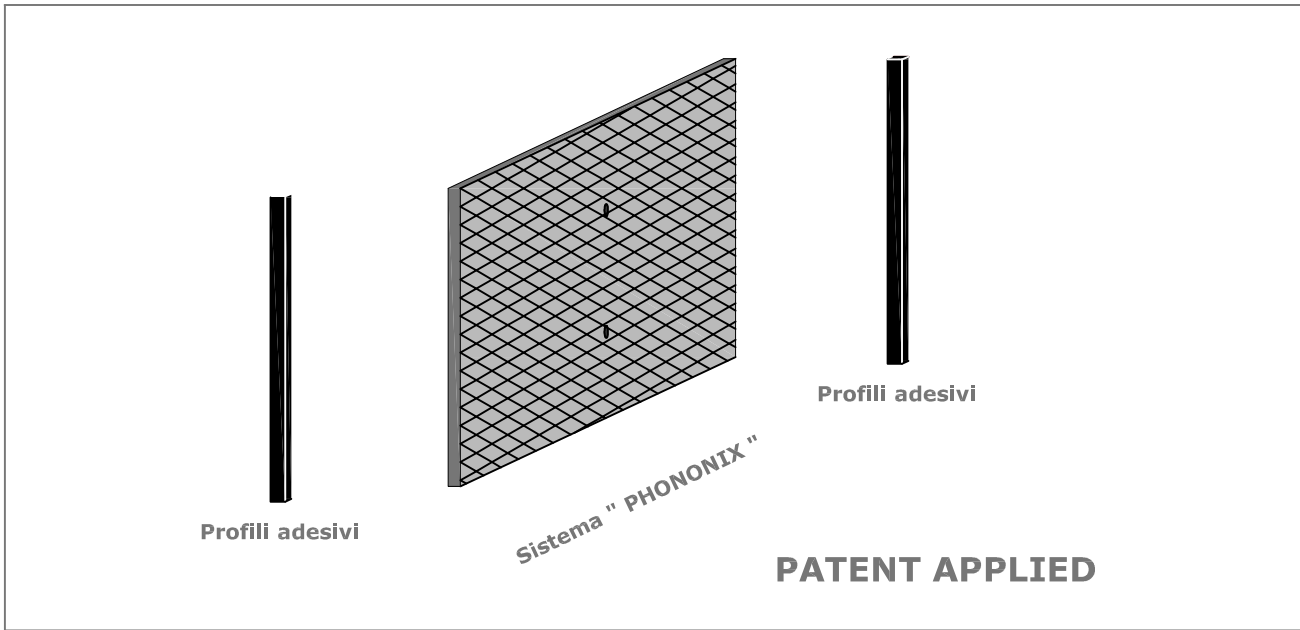

ACCESSORI per l'ASSEMBLAMENTO

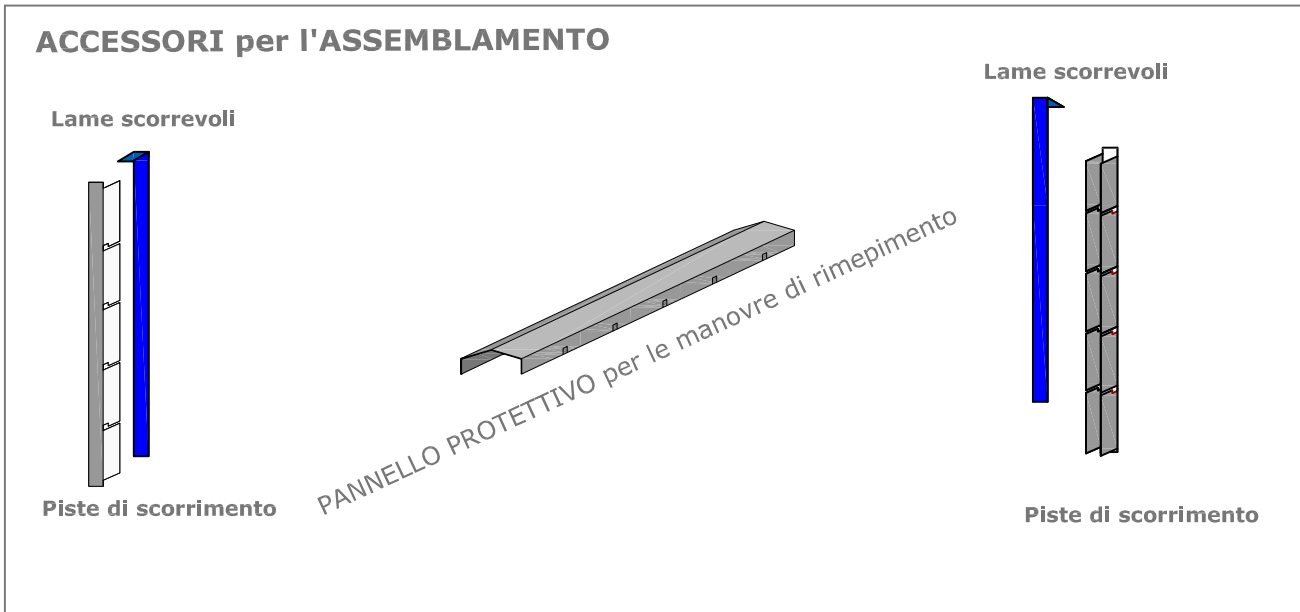

ACCESSORI per le manovre di SOLLEVAMENTO

