

ISTRUZIONI DI MONTAGGIO

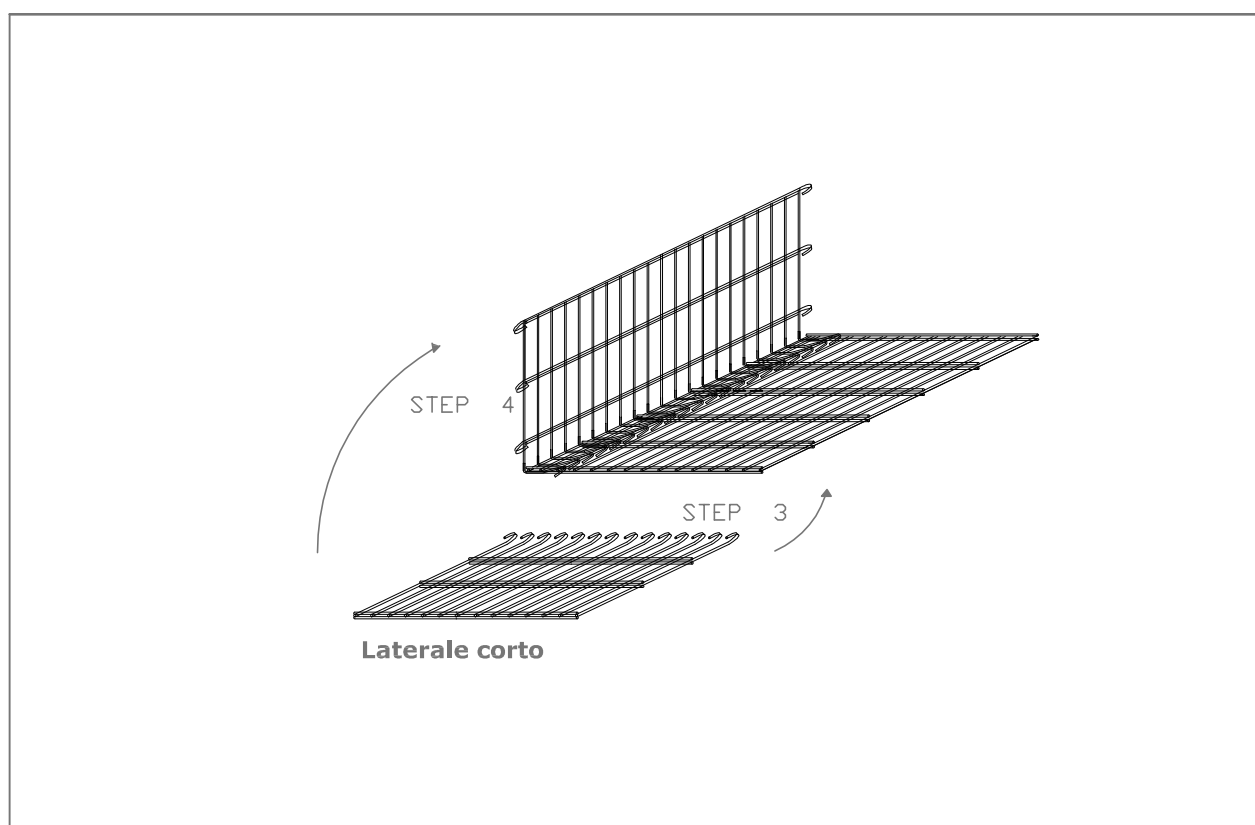

Con il sistema altamente **PHONONIX** Gabbia con marcatura
fono-assorbente

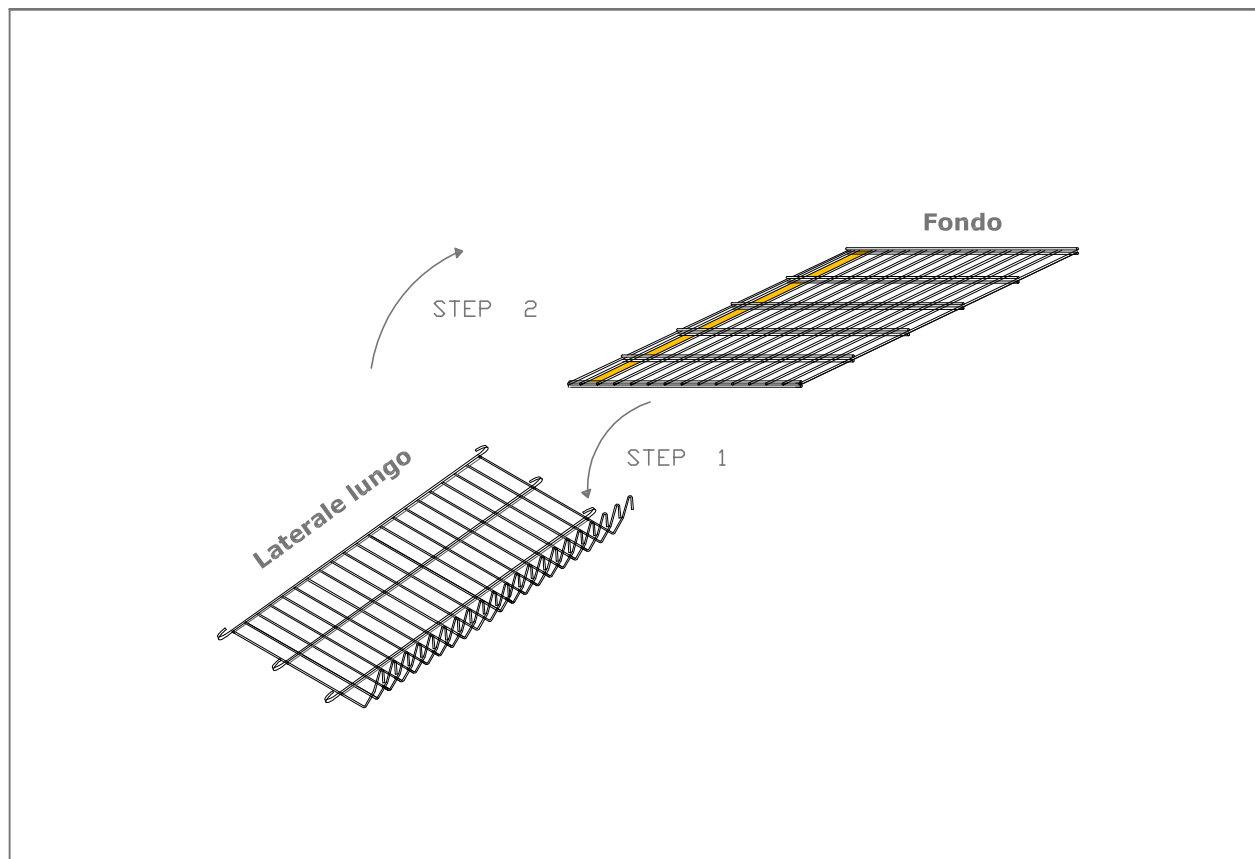

ISTRUZIONI DI MONTAGGIO

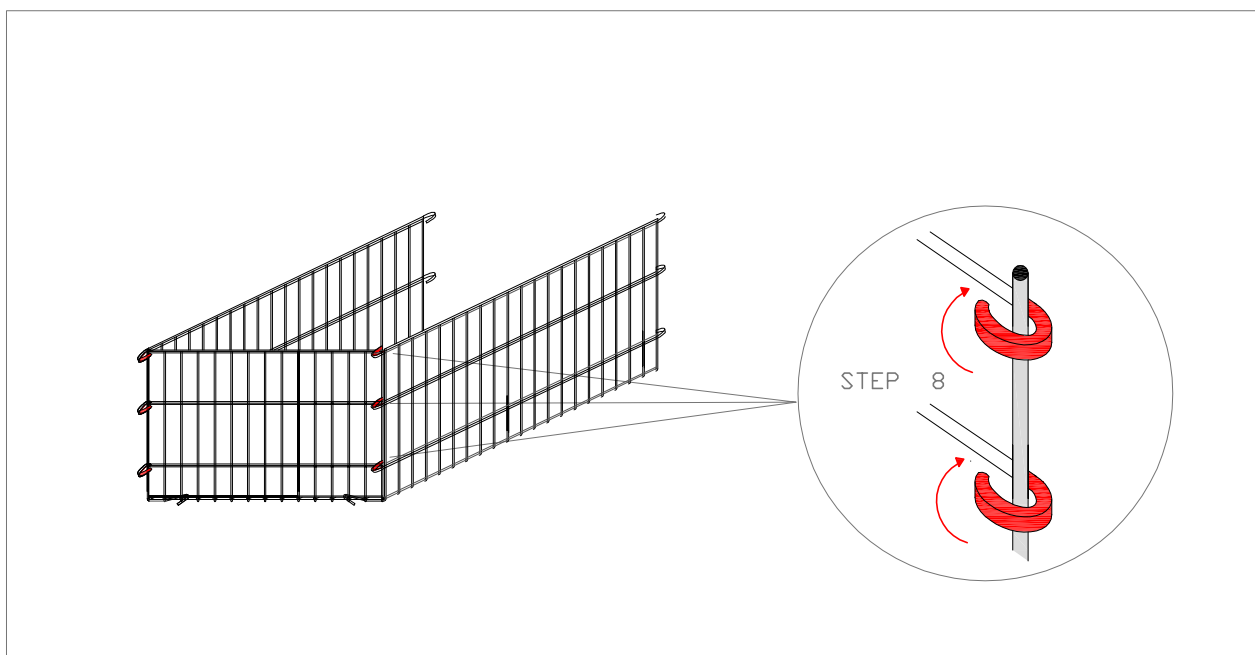
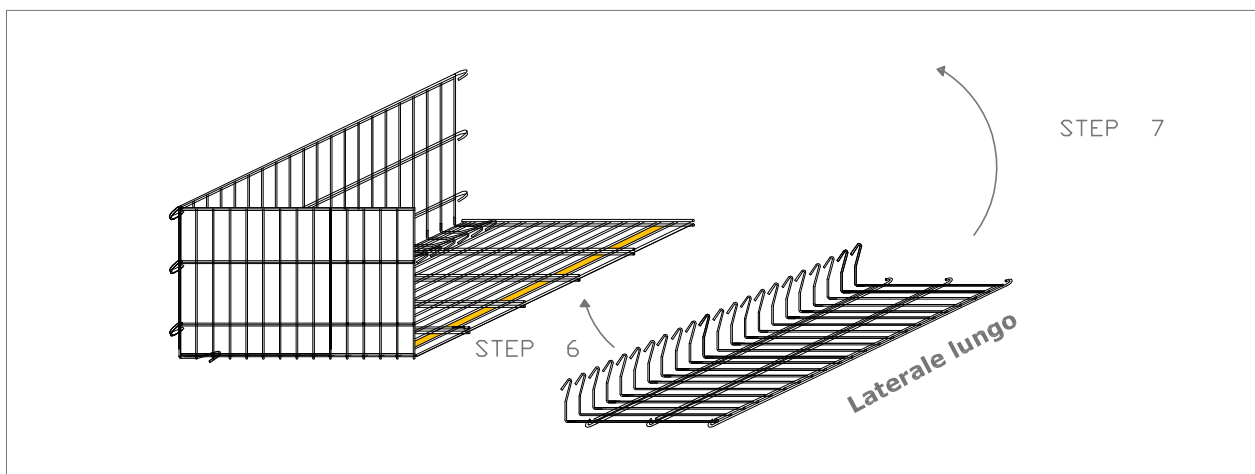
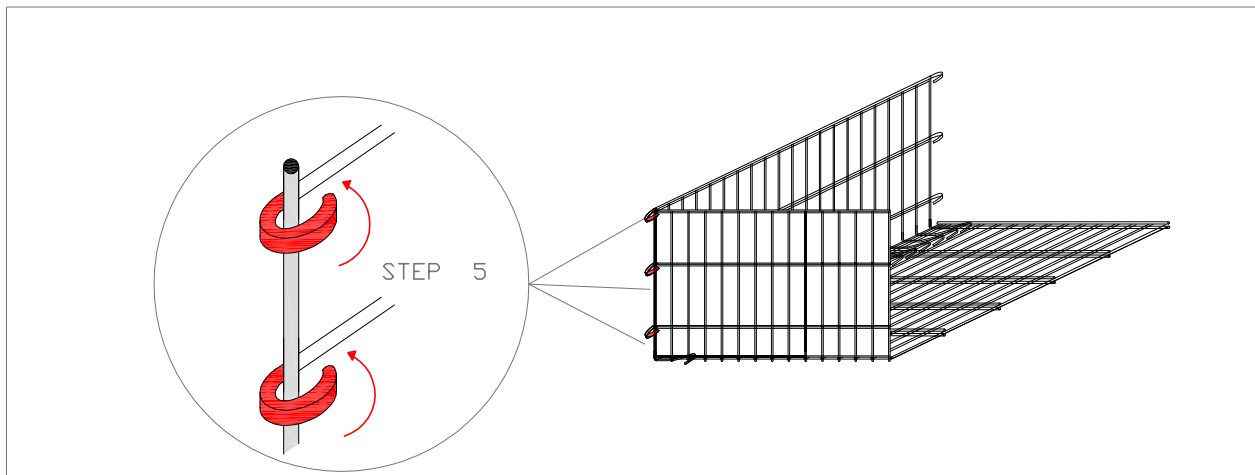

Gabbia con marcatura

PHONONIX

**Con il sistema altamente
fono-assorbente**

ISTRUZIONI DI MONTAGGIO

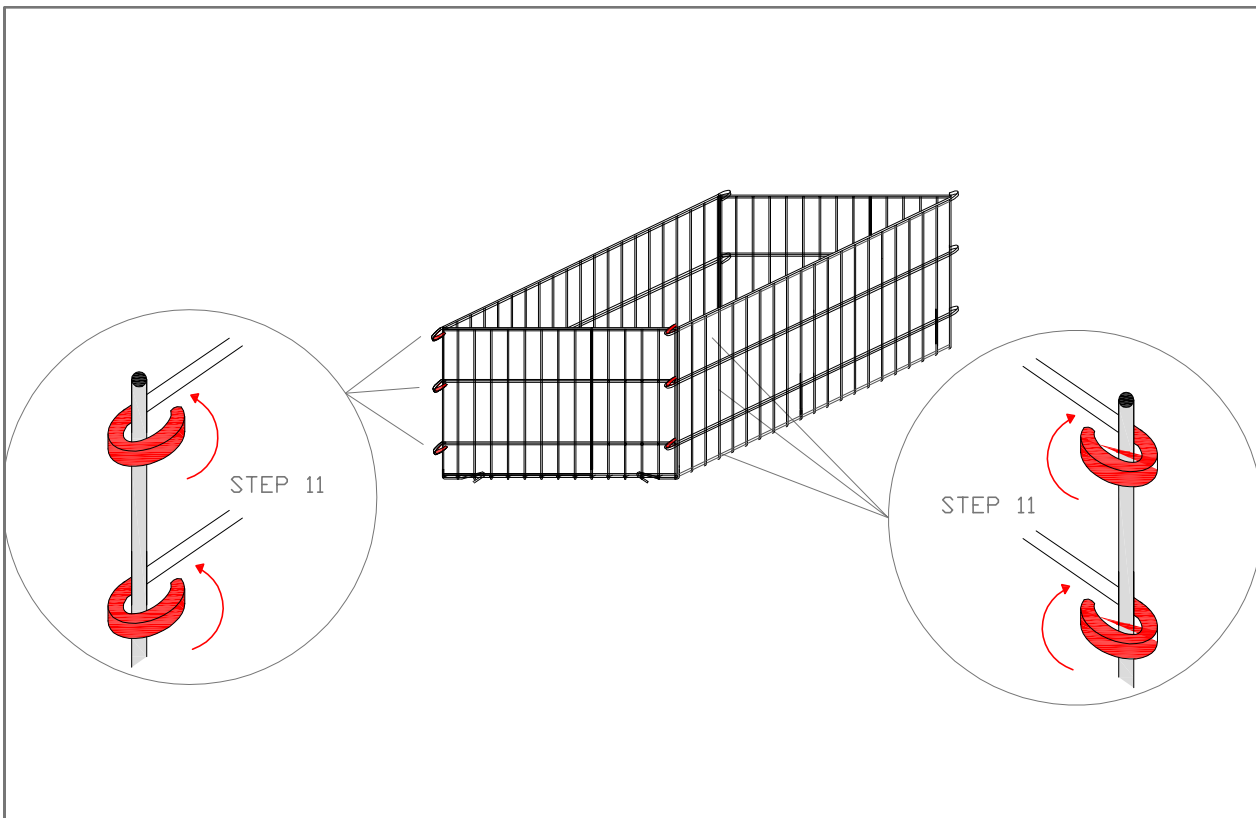
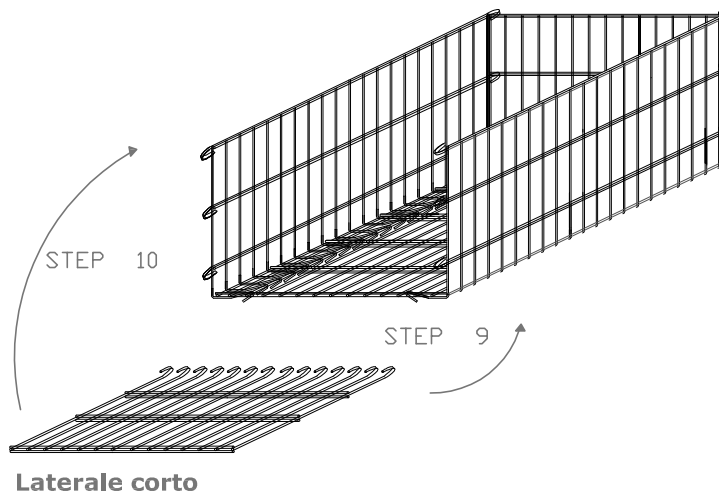

ISTRUZIONI DI MONTAGGIO

PATENT APPLIED

AGGANCIAMENTO DELLE PISTE DI SCORRIMENTO

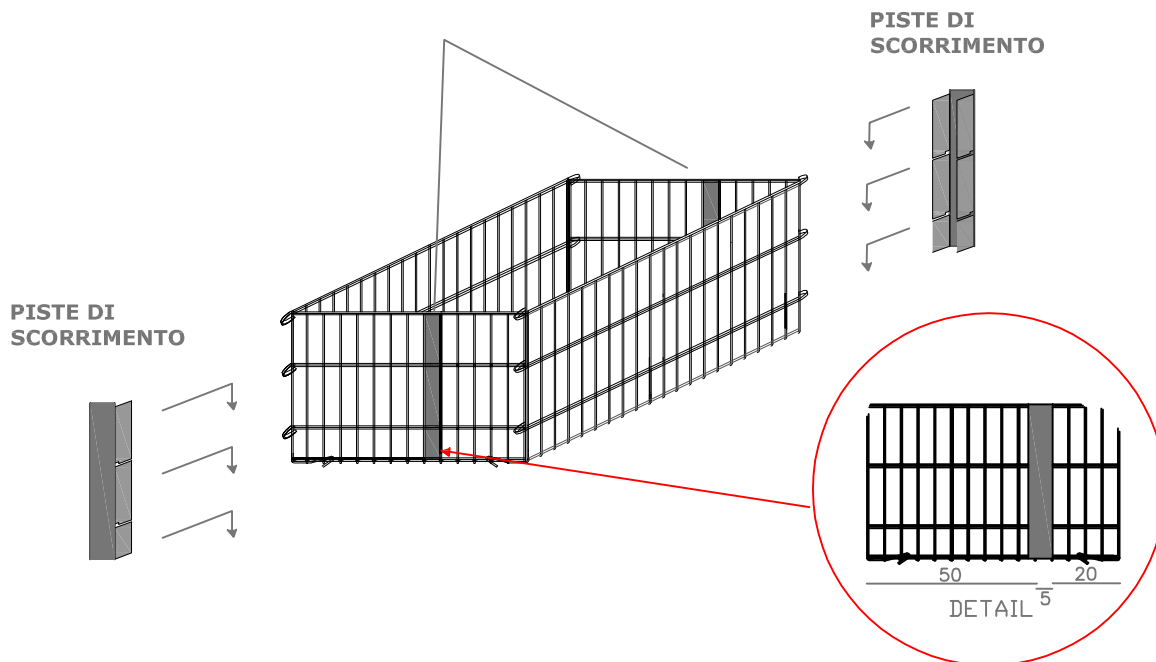

STEP 13

INSERIRE LE LAME SCORREVOLI NELLE PISTE DI SCORRIMENTO PER FACILITARE L'INSERIMENTO DEL PANNELLO FONOASSORBENTE

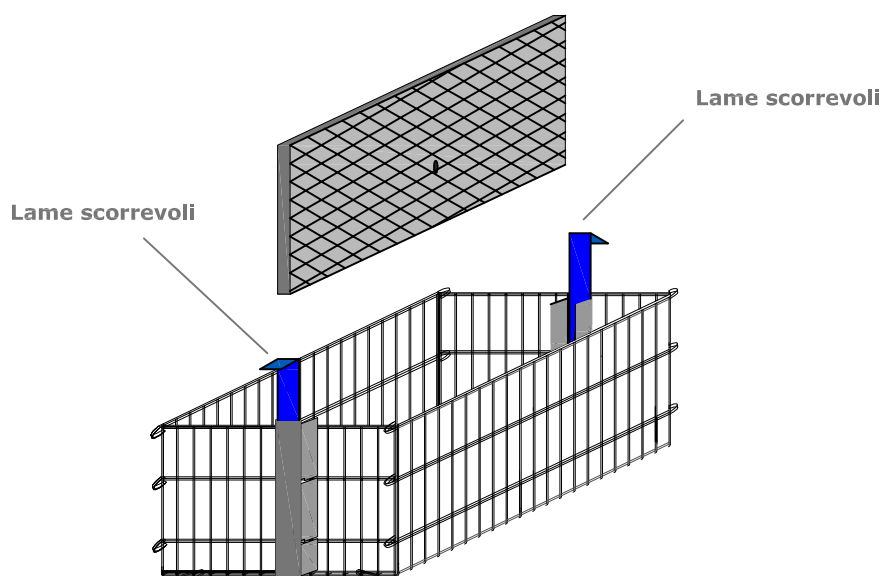

Rimuovere le lame scorrevoli dopo aver inserito il pannello fonoassorbente

PHONONIX Gabbia con marcatura
Con il sistema altamente
fono-assorbente

PATENT APPLIED

STEP 14

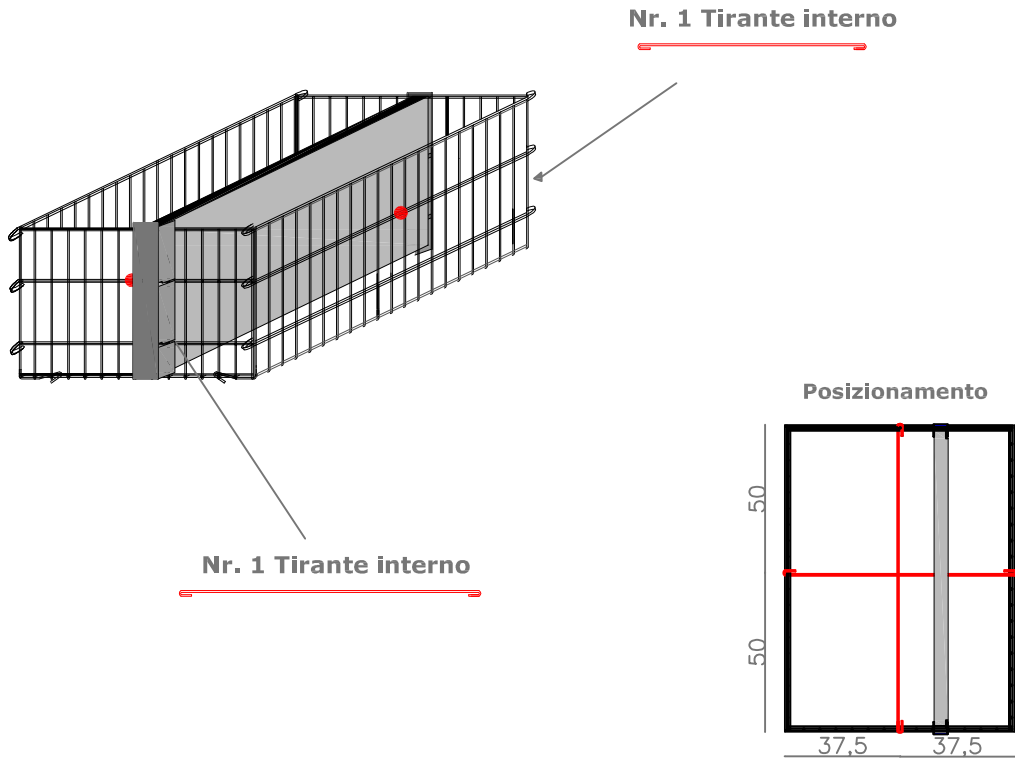

PANNELLO PROTETTIVO per le manovre di riempimento

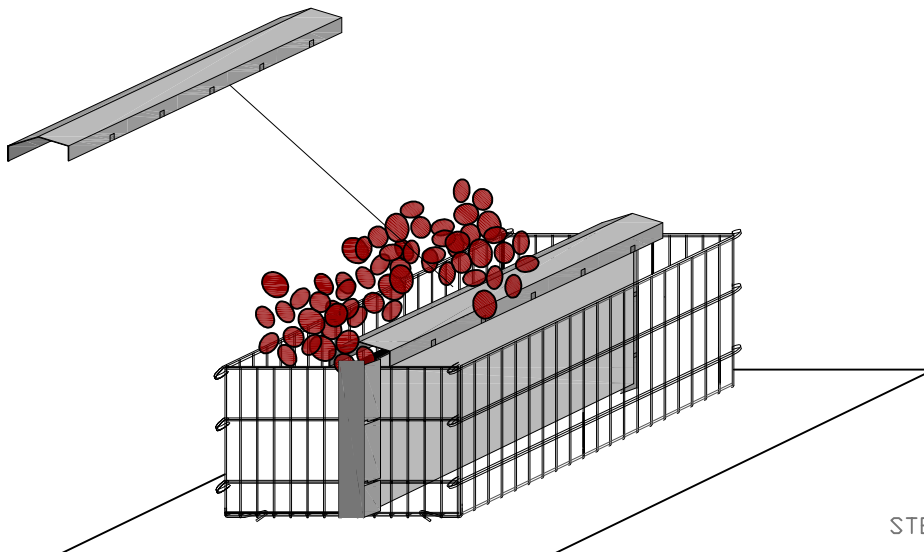

STEP 15

Riempire e compattare

PATENT APPLIED

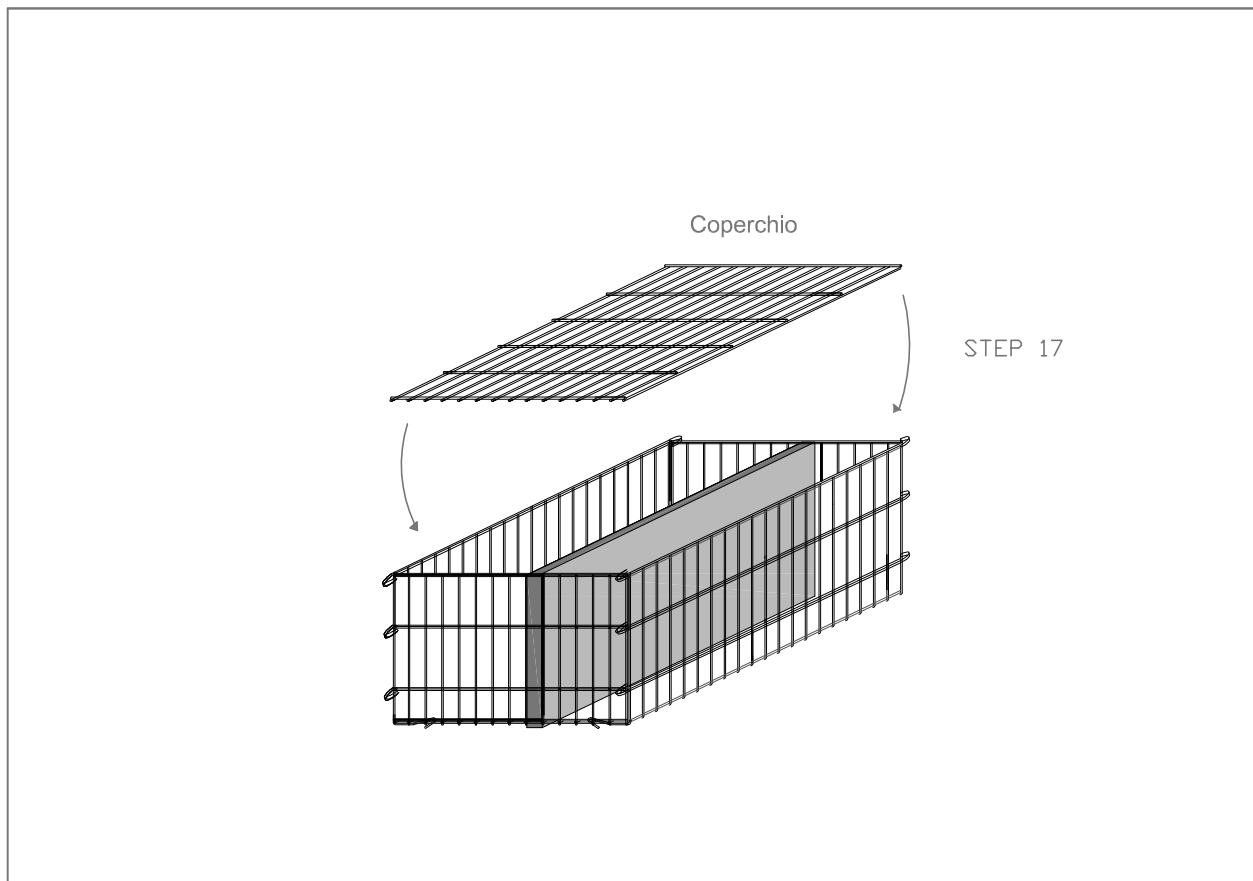
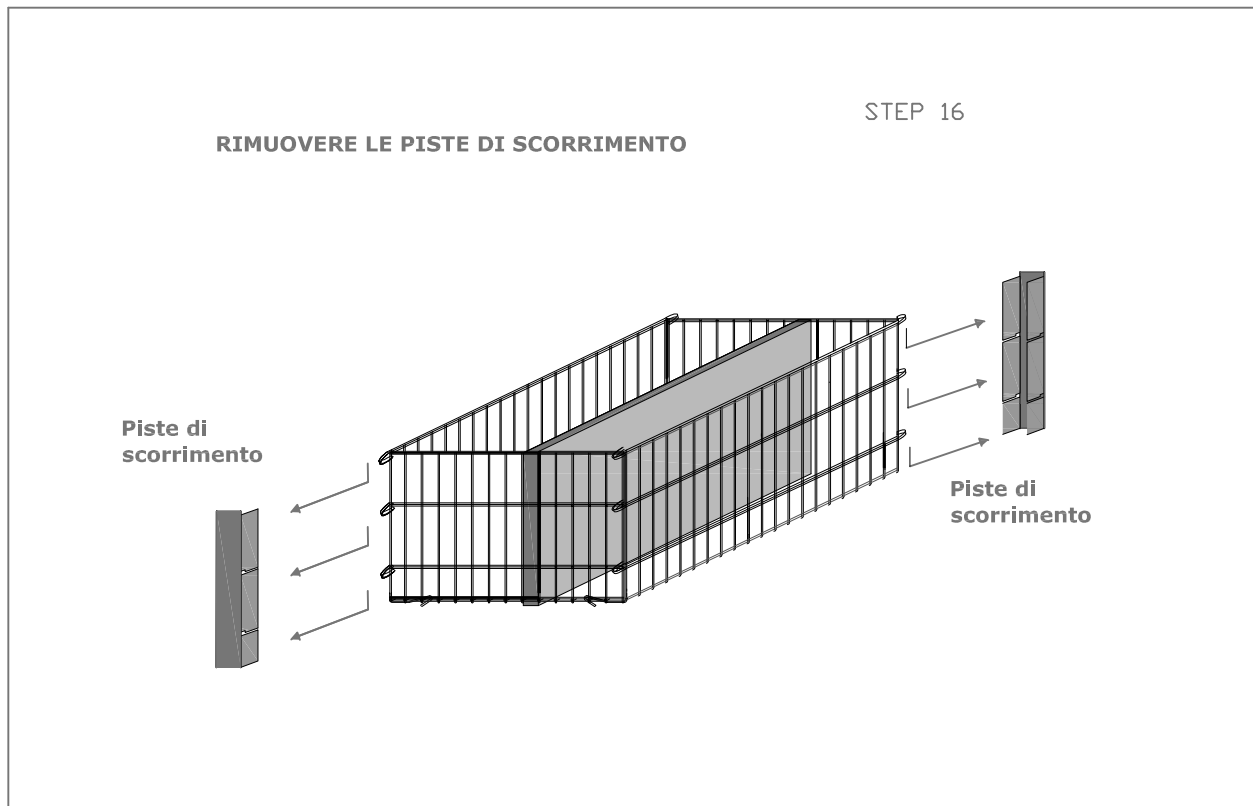

PATENT APPLIED

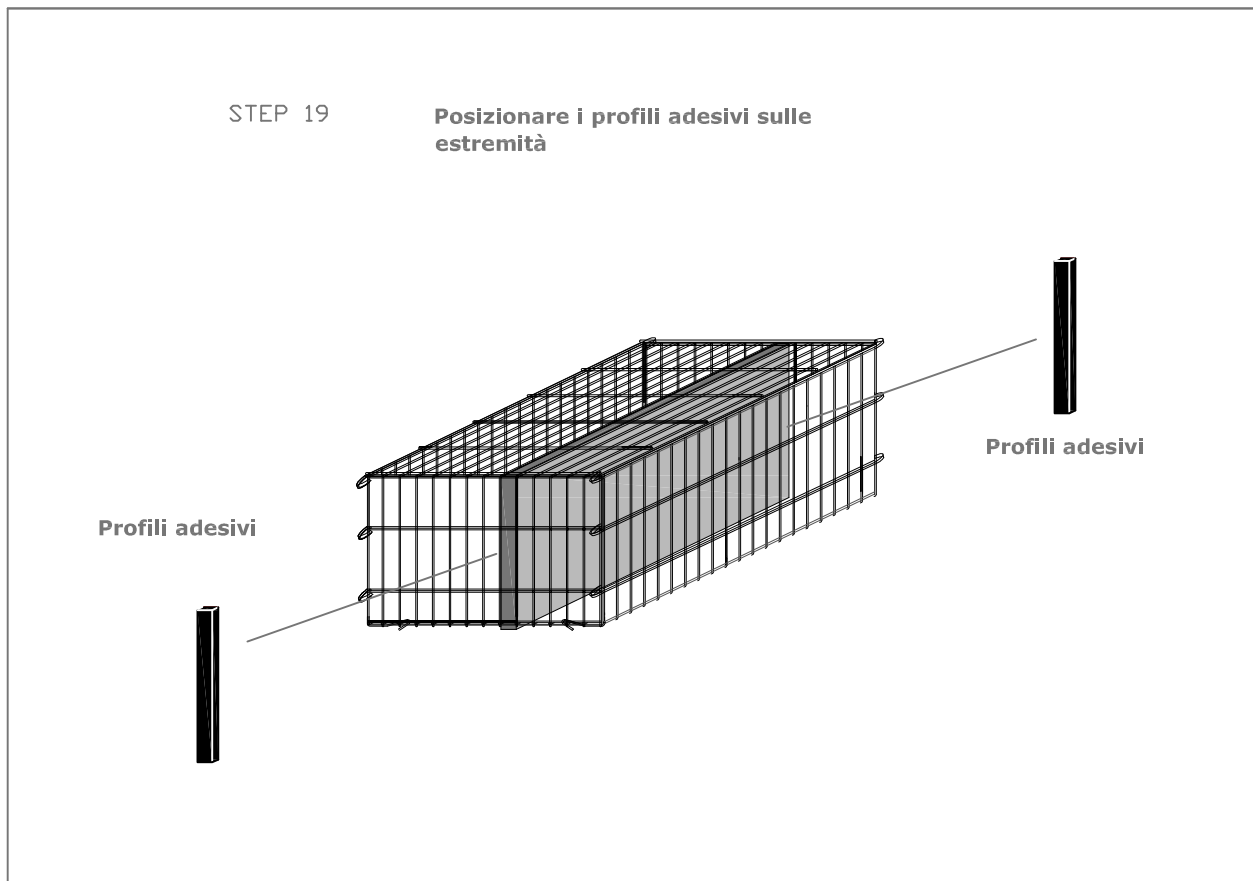
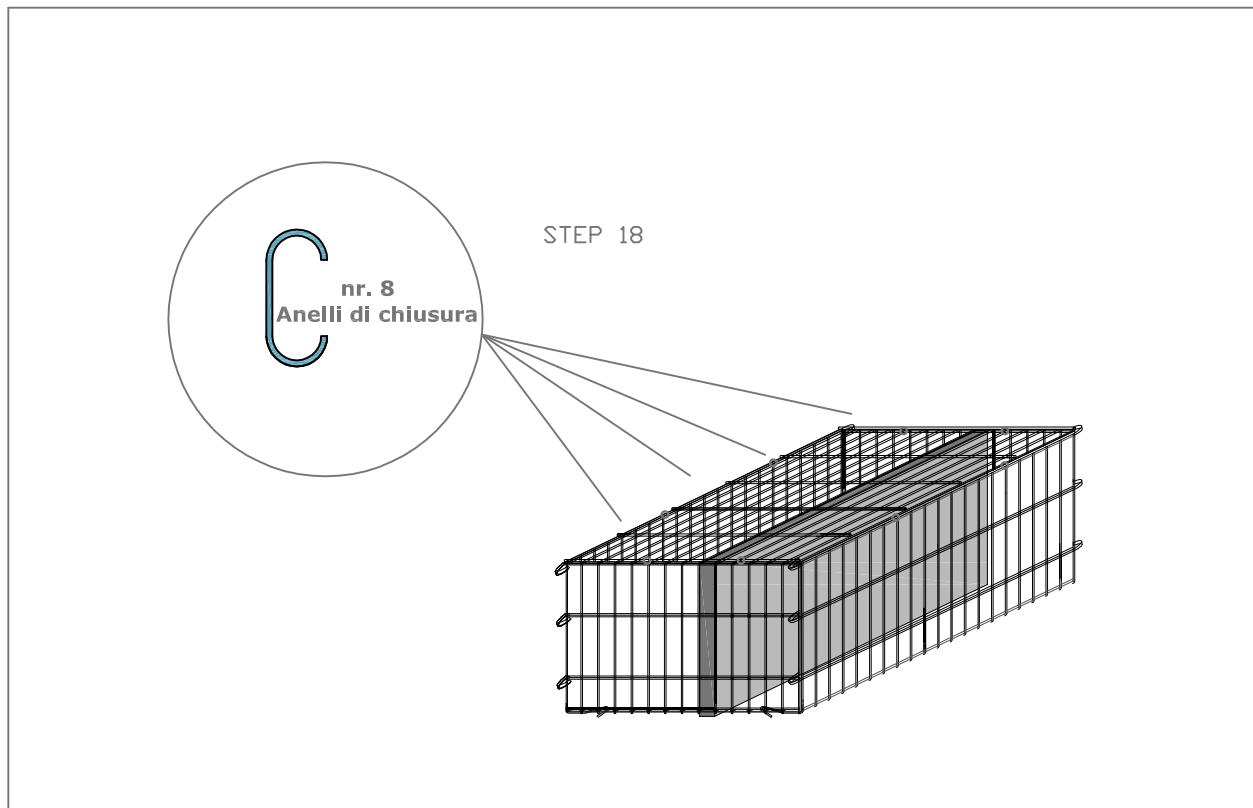

Gabbia con marcatura

PHONONIX

Con il sistema altamente
fono-assorbente



PATENT APPLIED

INSTALLAZIONE IN CANTIERE

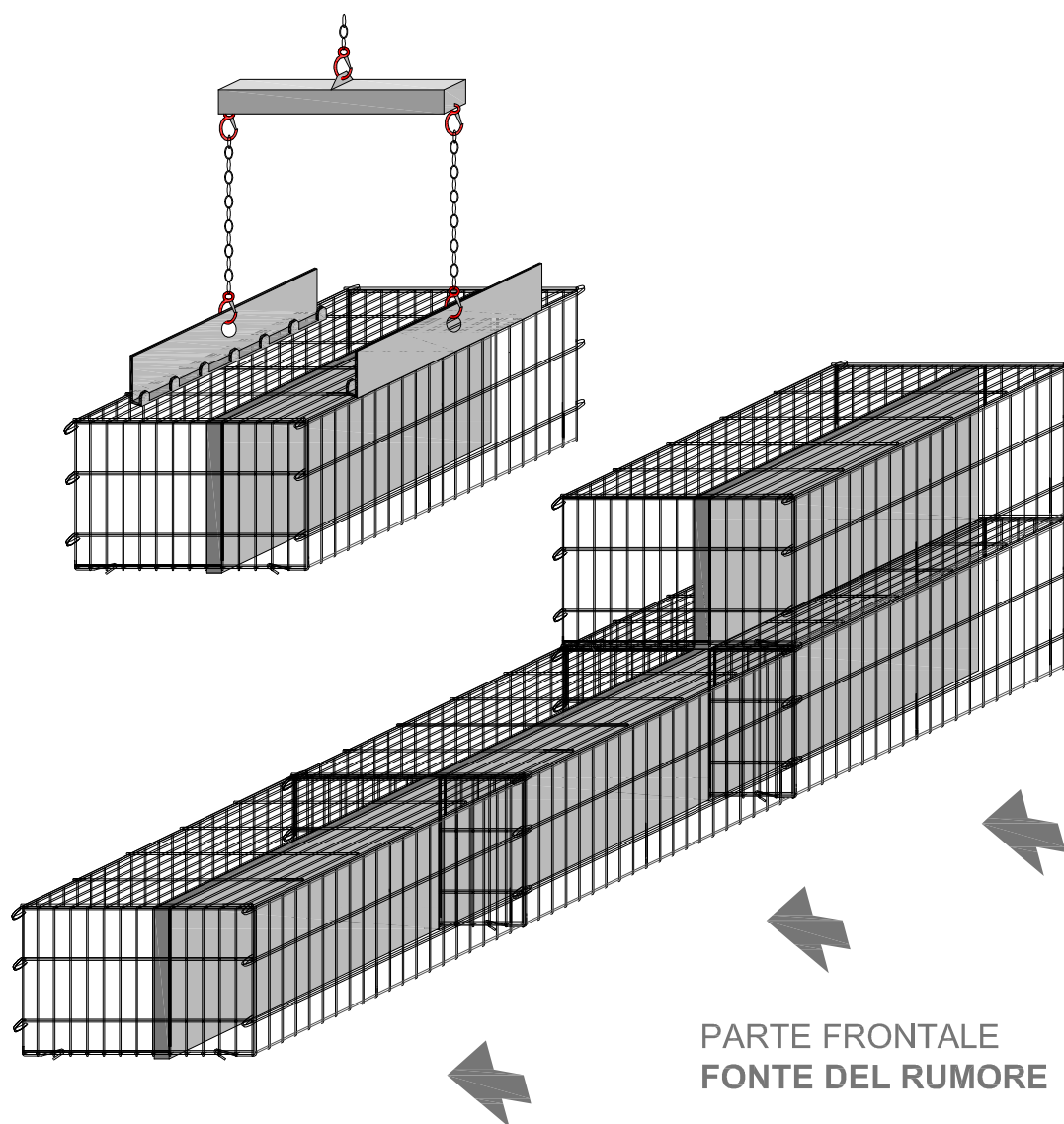

Con il sistema altamente
fono-assorbente **PHONONIX** Gabbia con marcatura

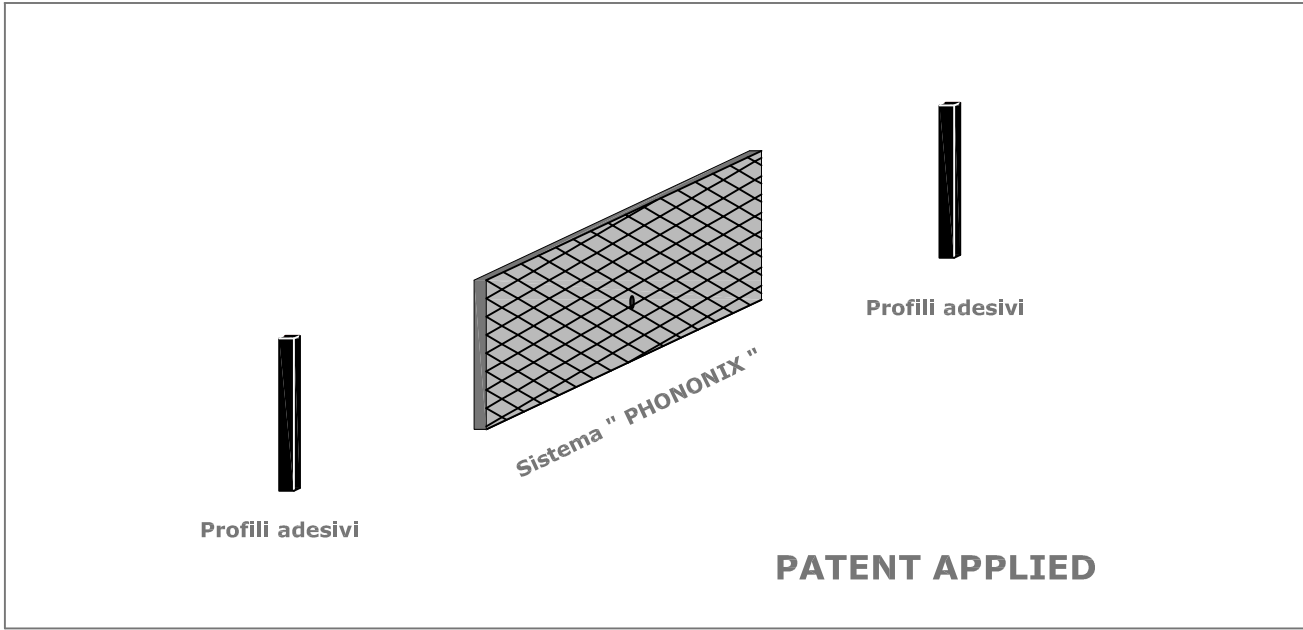

ACCESSORI per l'ASSEMBLAMENTO

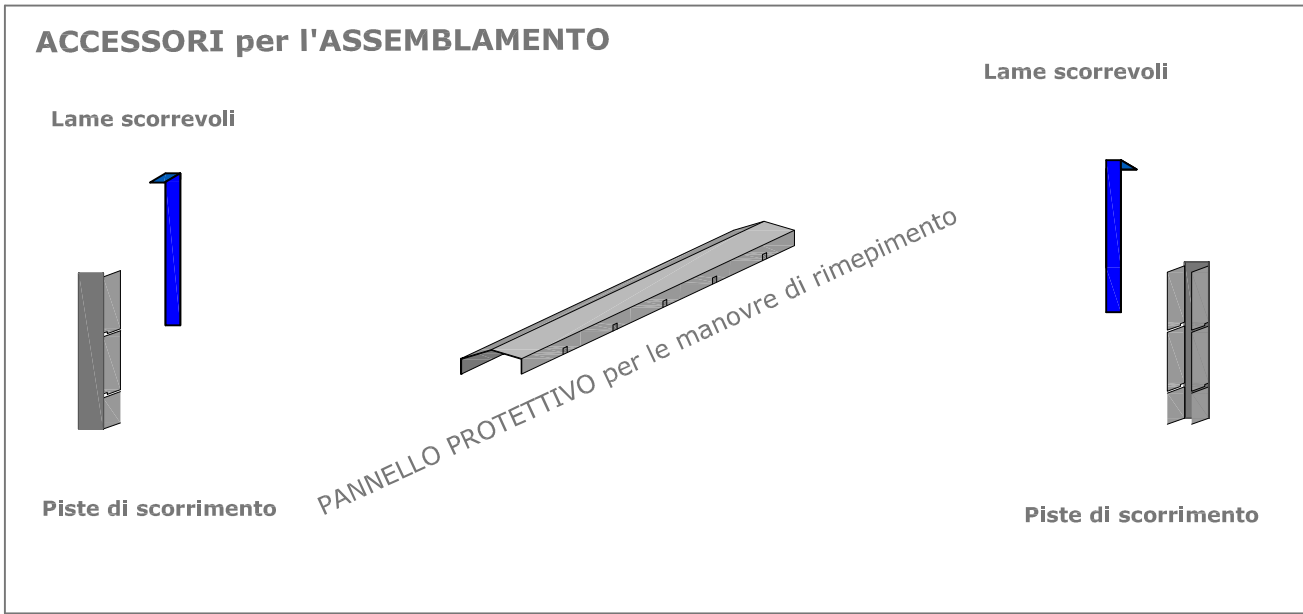

ACCESSORI per le manovre di SOLLEVAMENTO

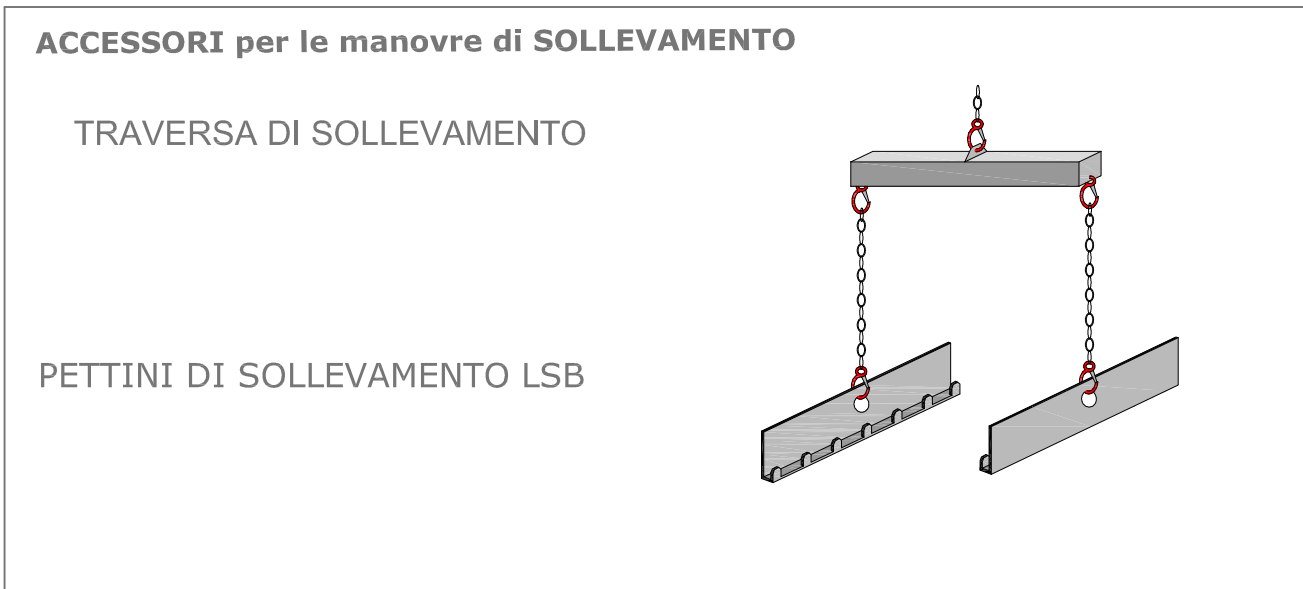

PHONONIX
Con il sistema altamente
fono-assorbente

