

ISTRUZIONI DI MONTAGGIO

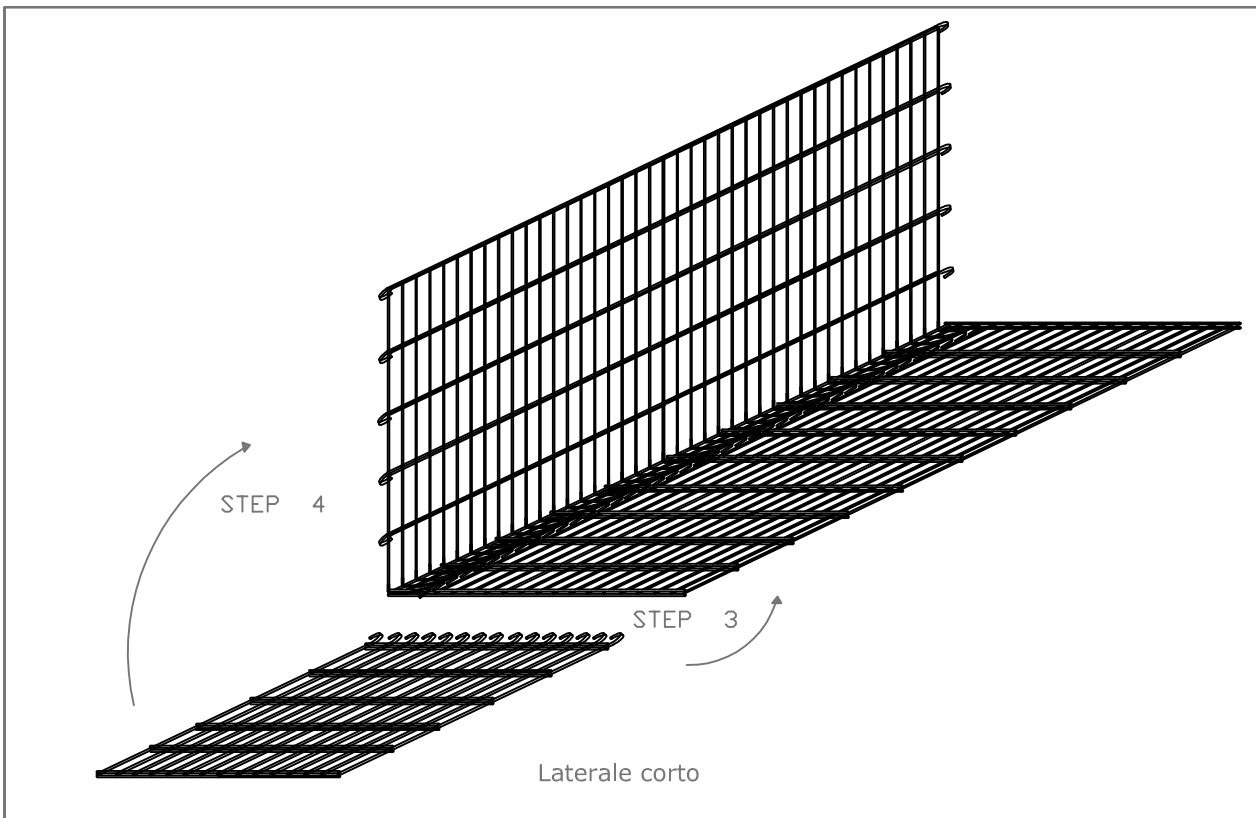

ISTRUZIONI DI MONTAGGIO

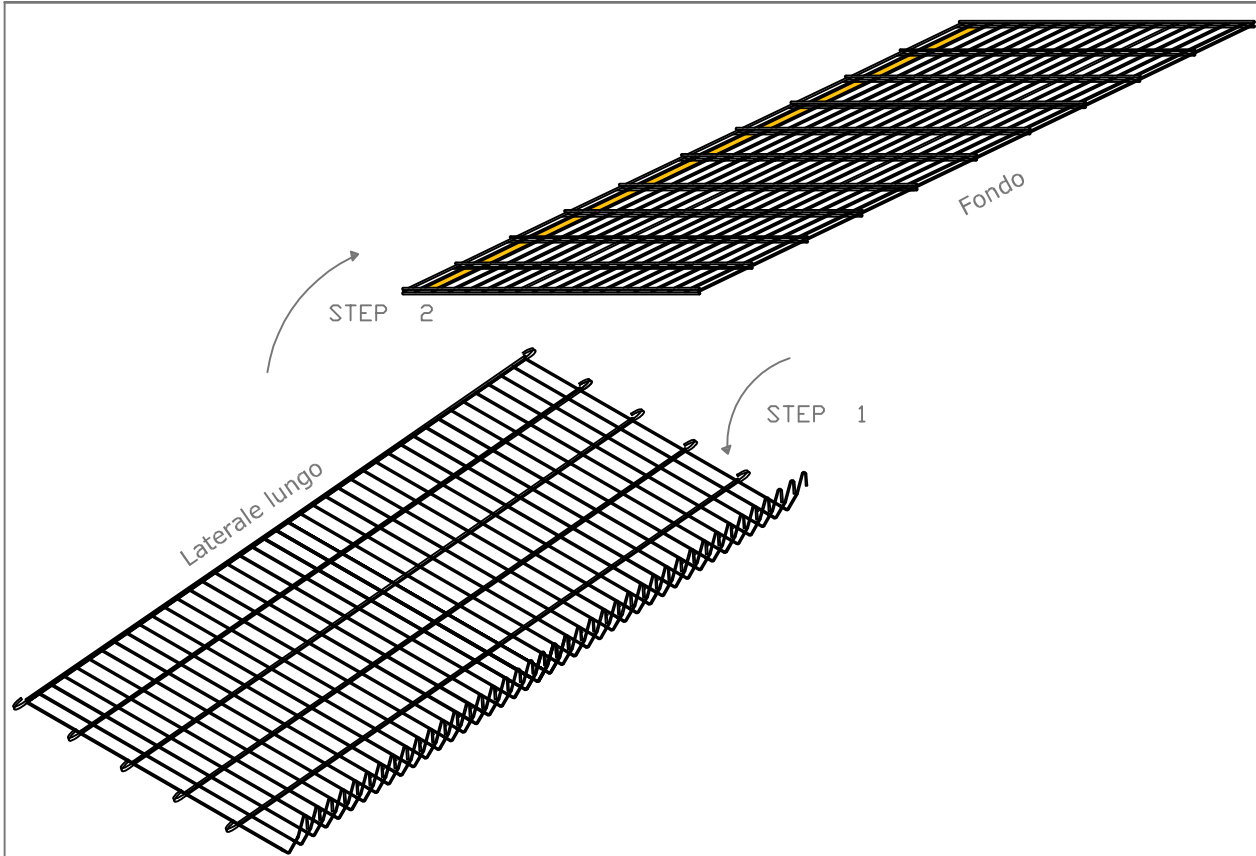
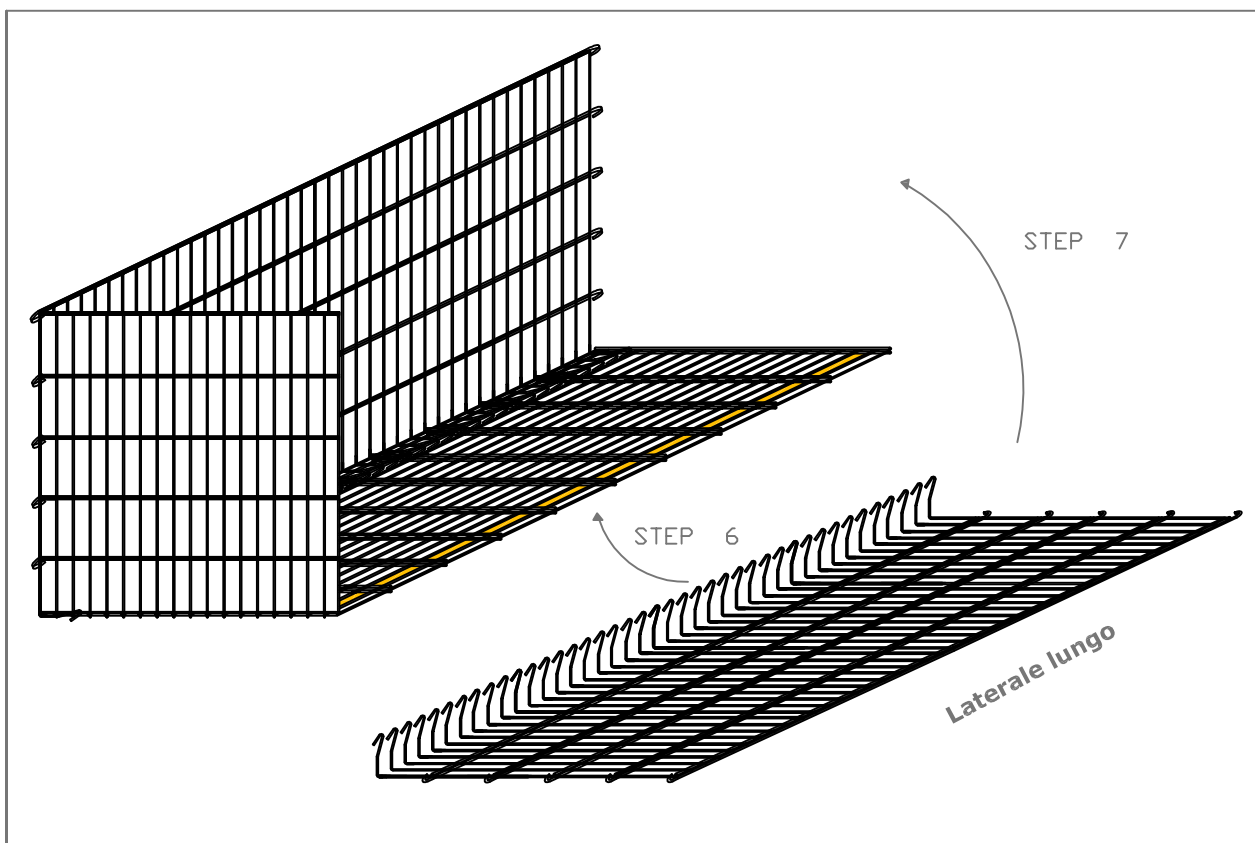
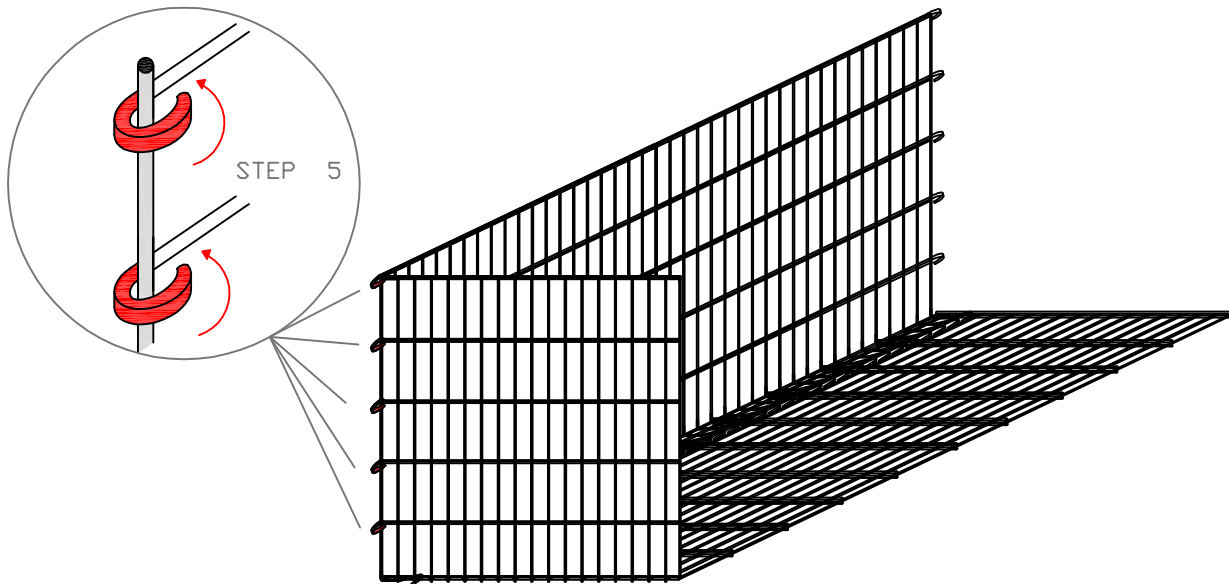

Gabbia con marcatura

PHONONIX

Con il sistema altamente
fono-assorbente



ISTRUZIONI DI MONTAGGIO

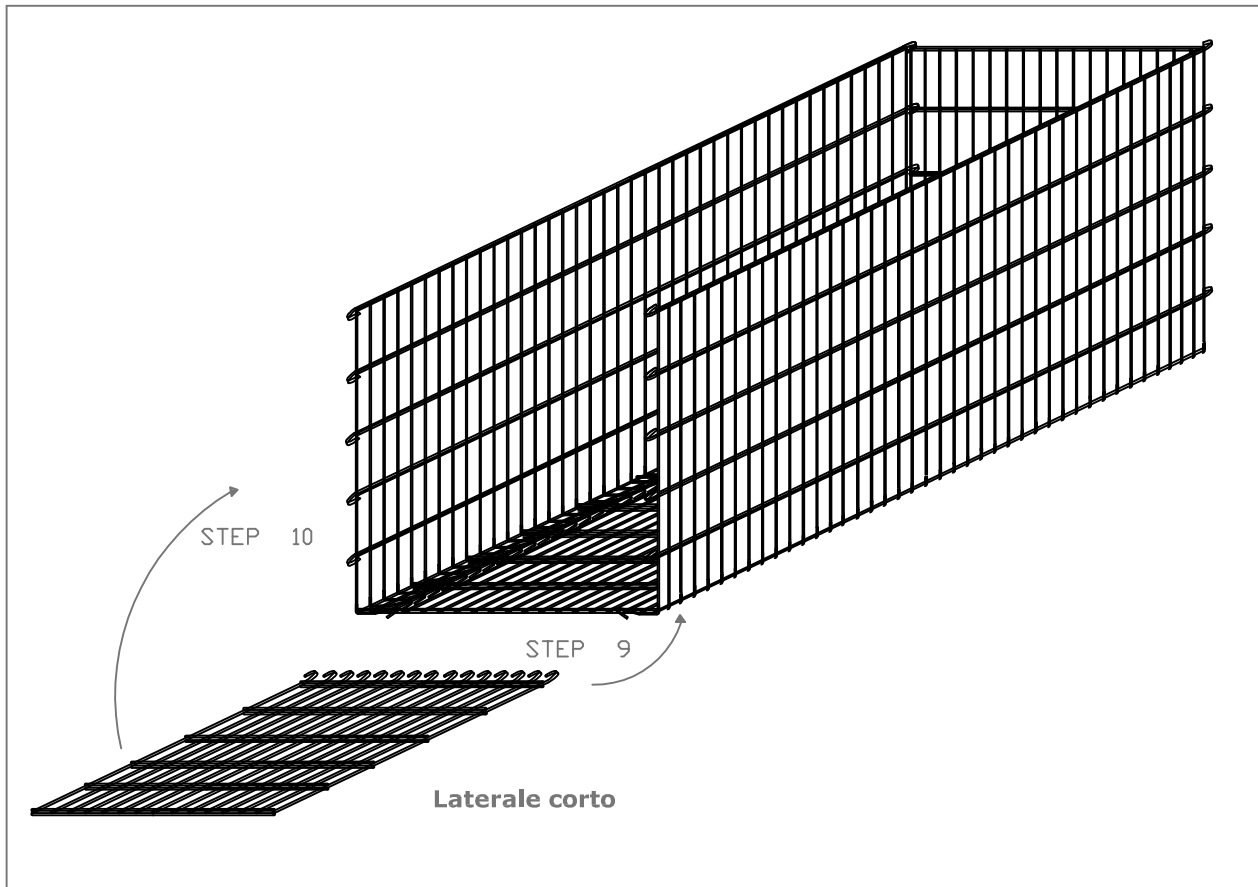
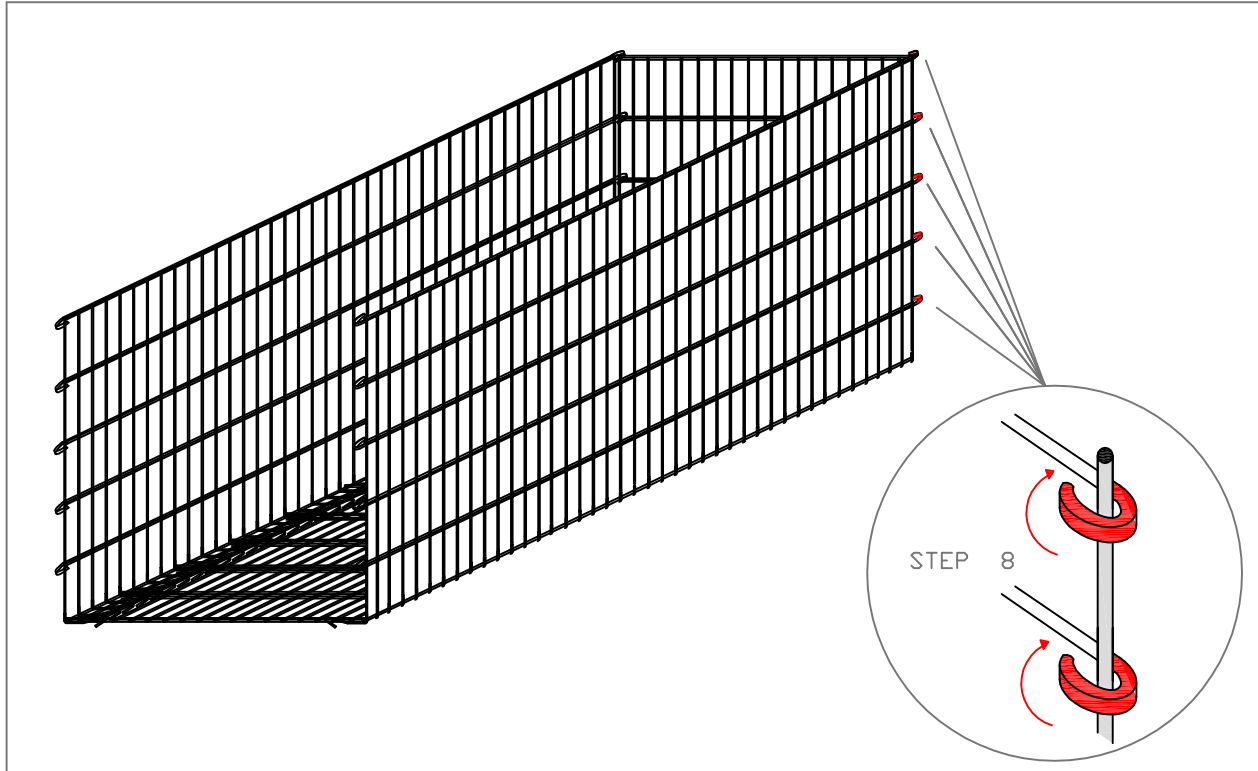

Gabbia con marcatura

PHONONIX

Con il sistema altamente
fono-assorbente



ISTRUZIONI DI MONTAGGIO

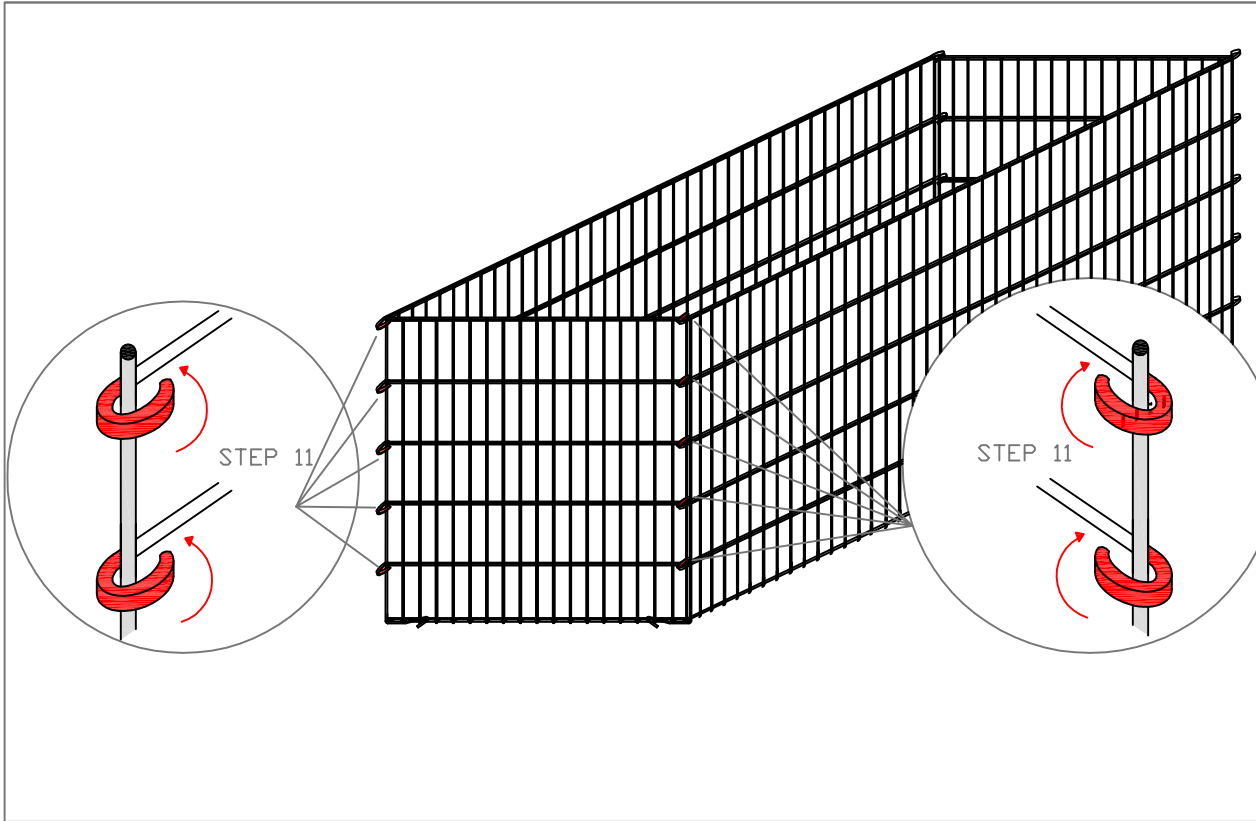

PATENT APPLIED

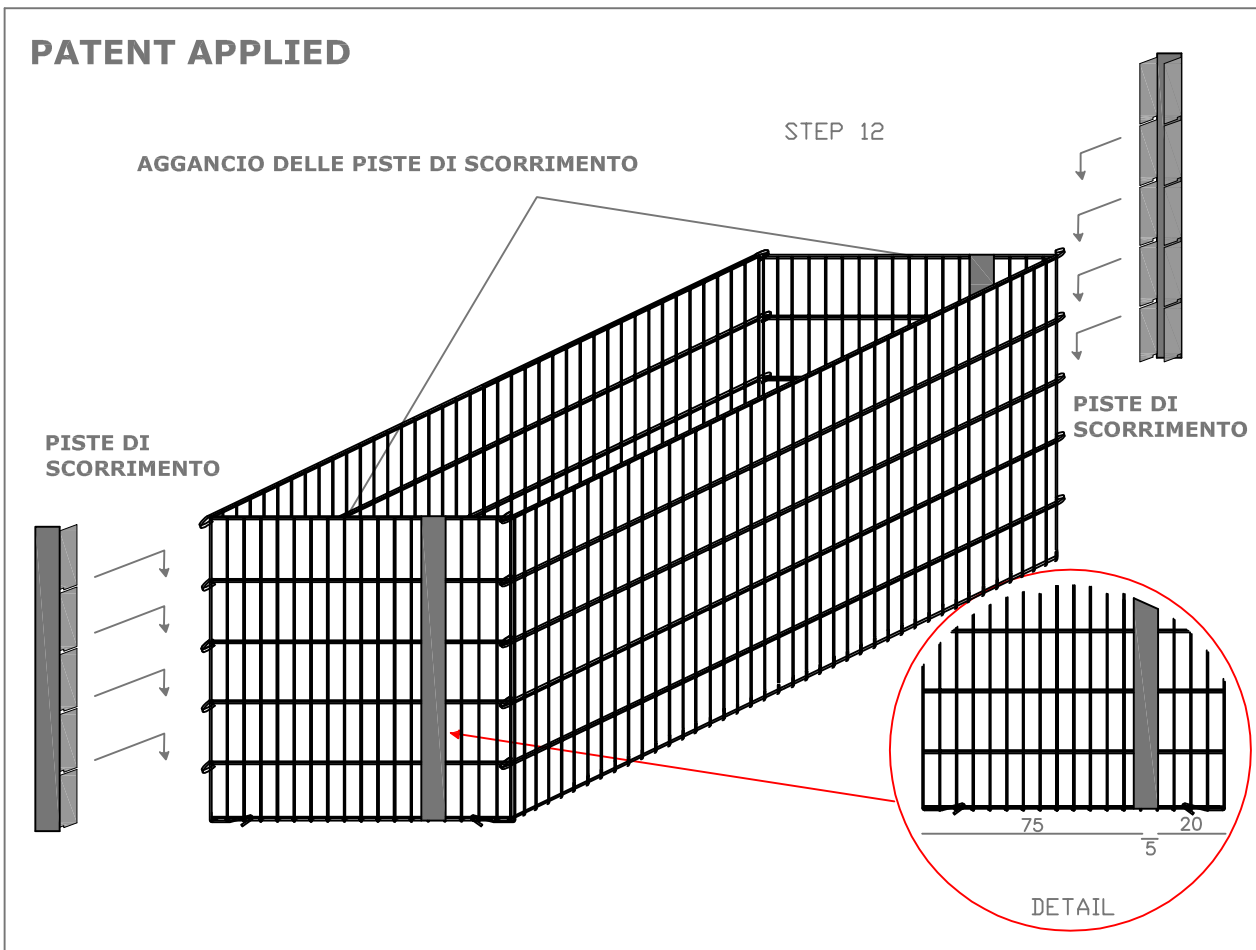

Gabbia con marcatura

PHONONIX

Con il sistema altamente
fono-assorbente



ISTRUZIONI DI MONTAGGIO

PATENT APPLIED

STEP 13

INSERIRE LE LAME SCORREVOLI NELLE PISTE DI SCORRIMENTO PER FACILITARE L'INSERIMENTO DEL PANNELLO FONOASSORBENTE

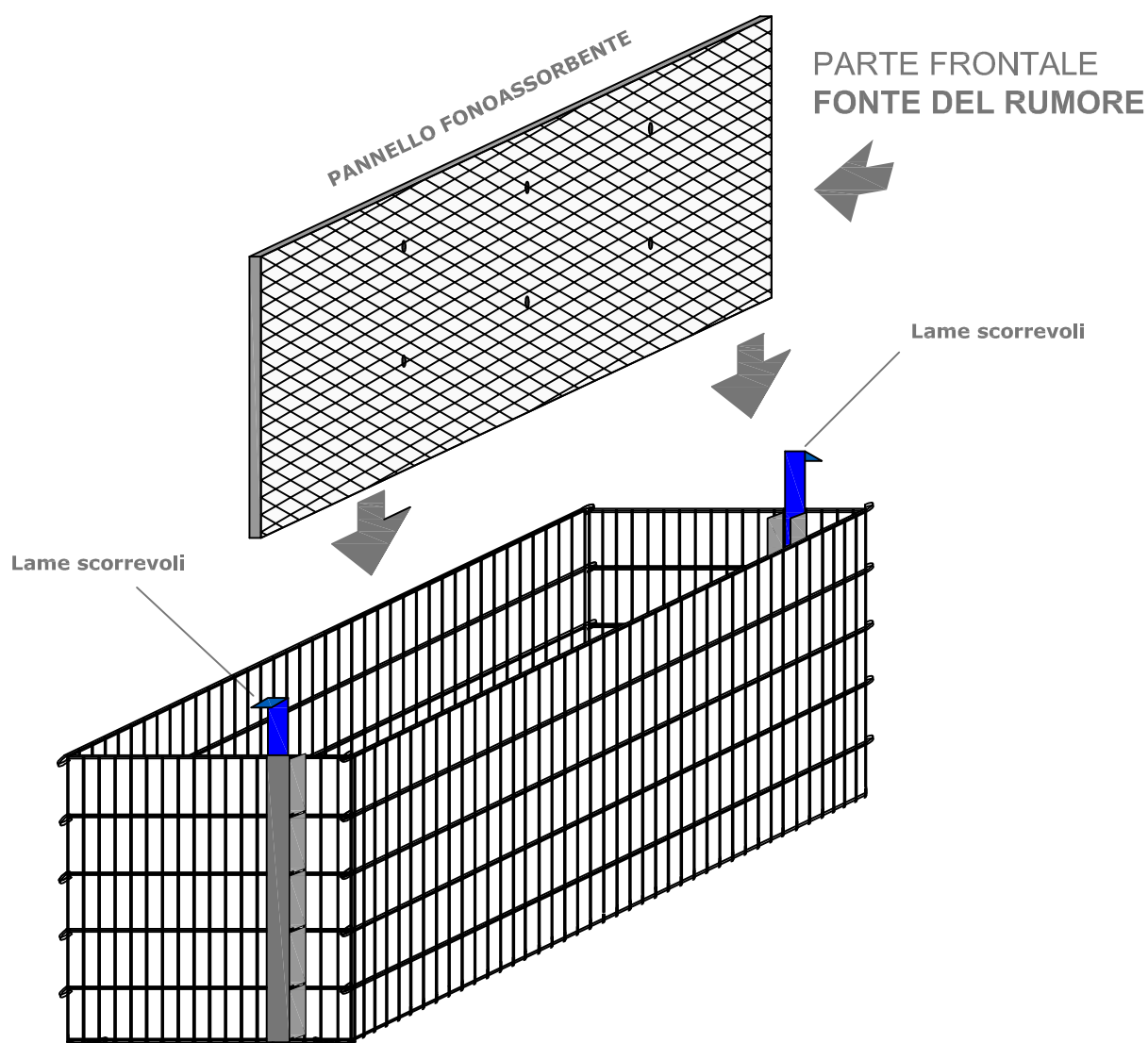

Rimuovere le lame scorrevoli dopo aver inserito il pannello fonoassorbente

Gabbia con marcatura

PHONONIX

Con il sistema altamente
fono-assorbente



PATENT APPLIED

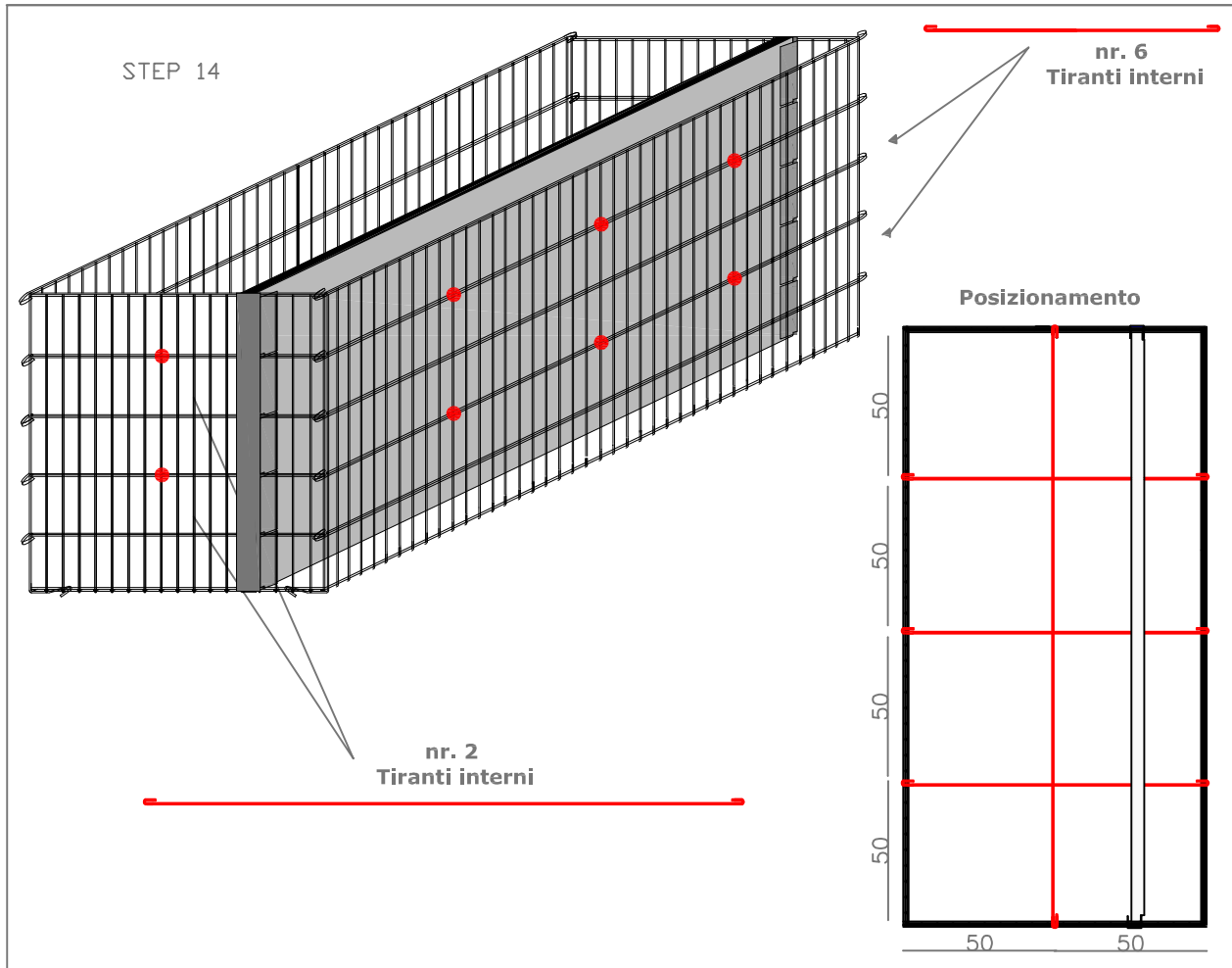

STEP

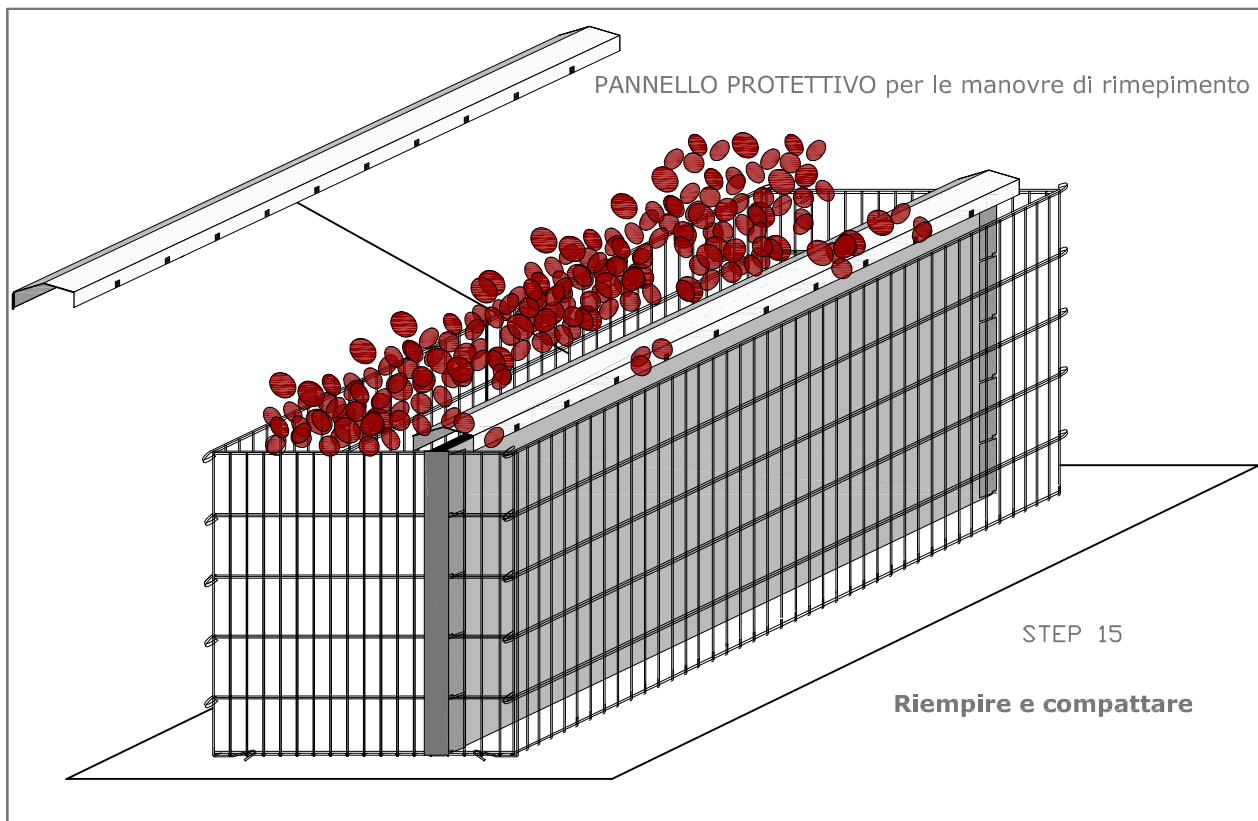

PATENT APPLIED

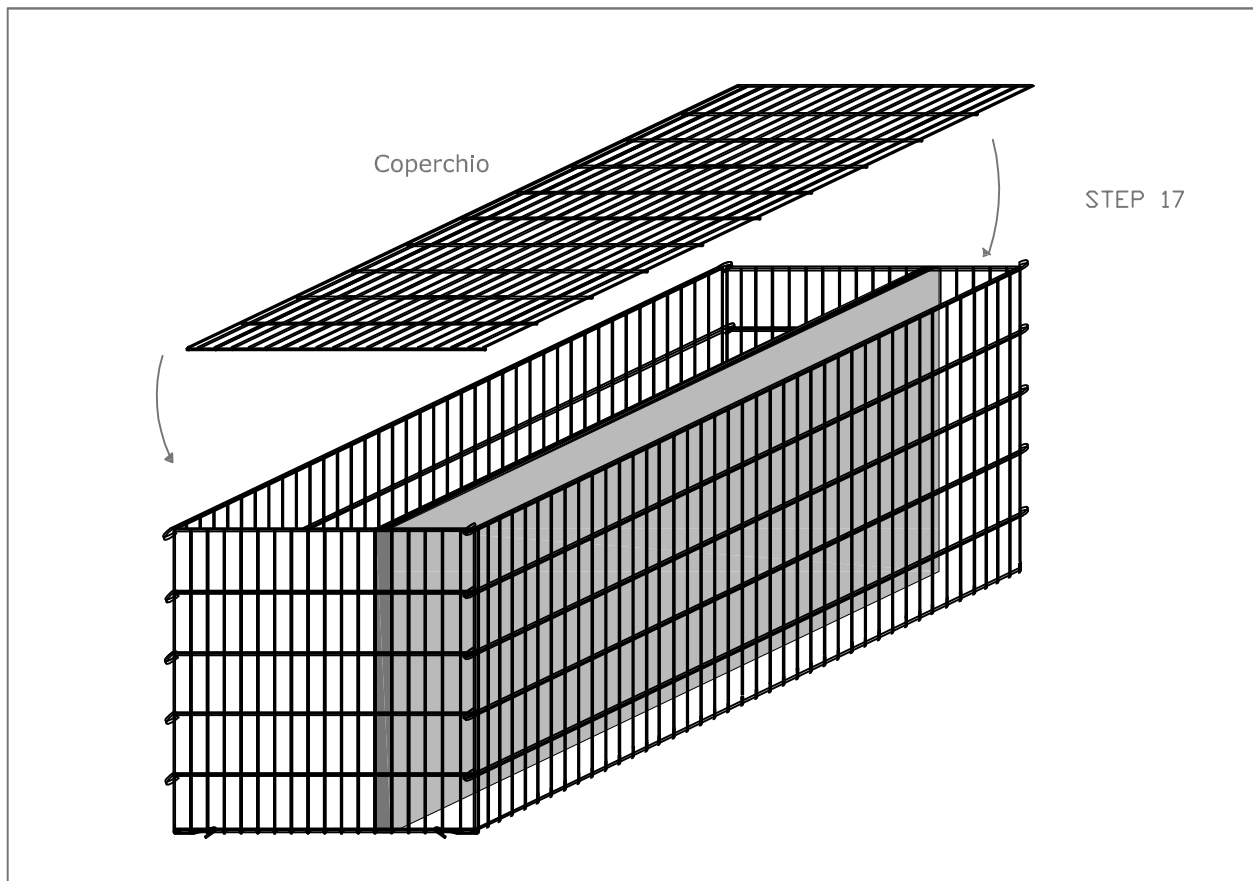
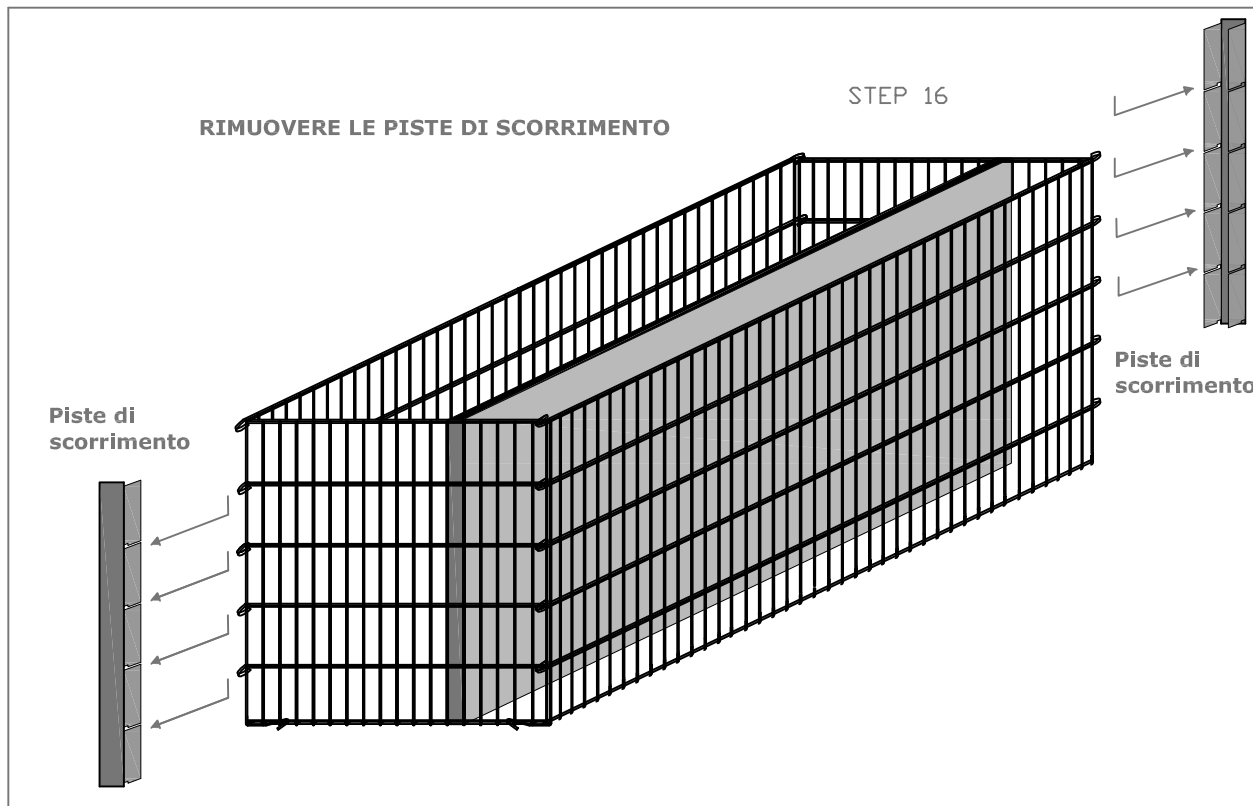

Gabbia con marcatura

PHONONIX

**Con il sistema altamente
fono-assorbente**

PATENT APPLIED

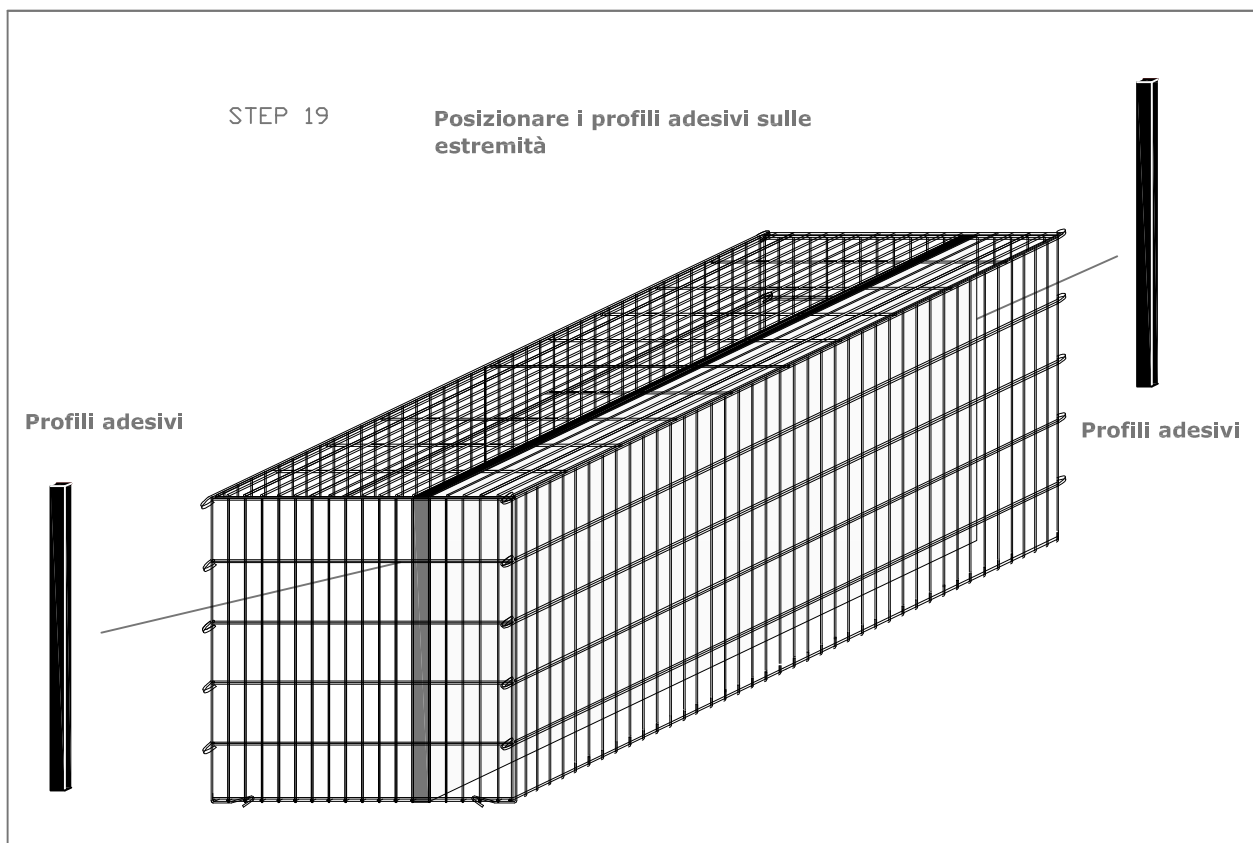
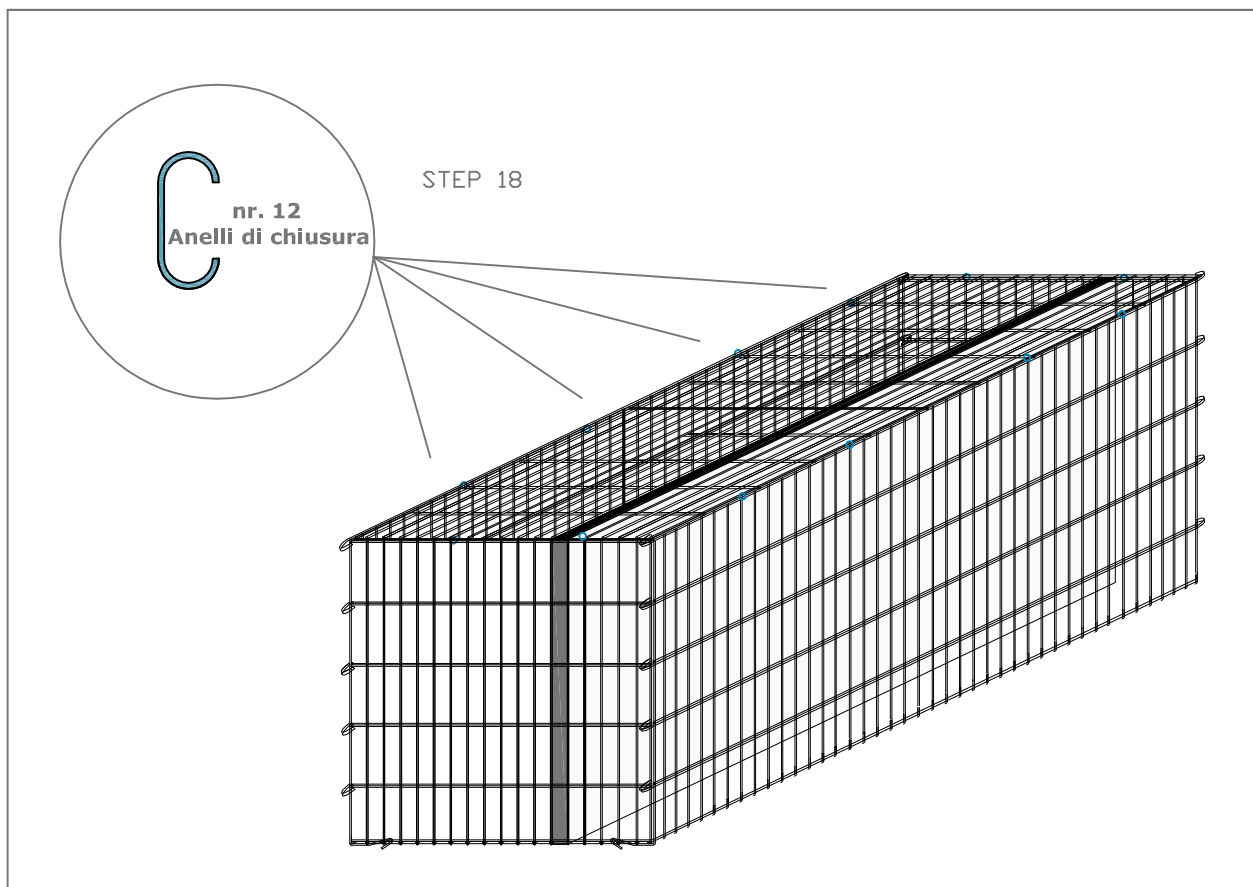

Gabbia con marcatura

PHONONIX

Con il sistema altamente
fono-assorbente



PATENT APPLIED

INSTALLAZIONE IN CANTIERE

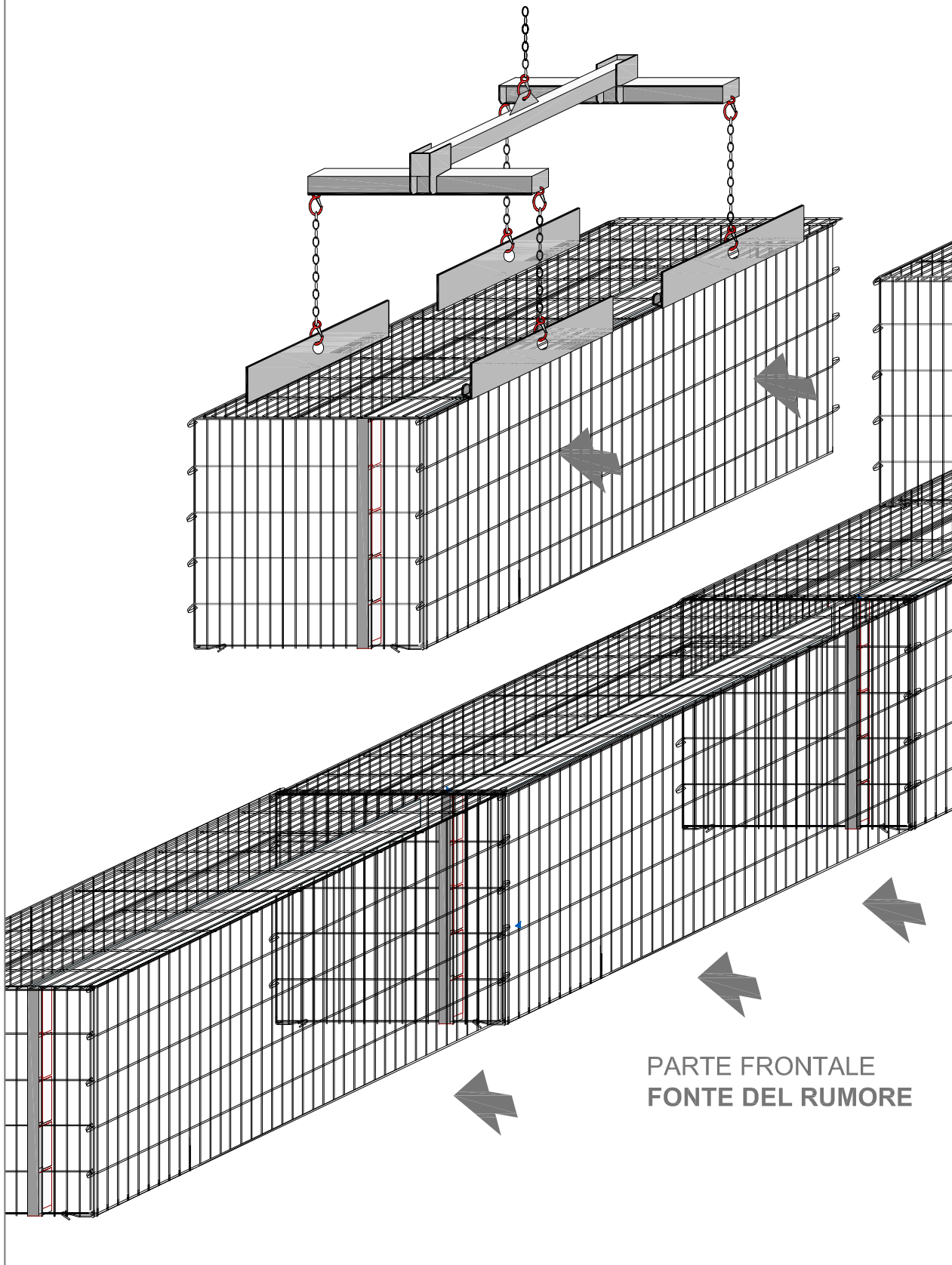

Gabbia con marcatura

PHONONIX

Con il sistema altamente
fono-assorbente



ACCESSORI per il SISTEMA FONOASSORBENTE

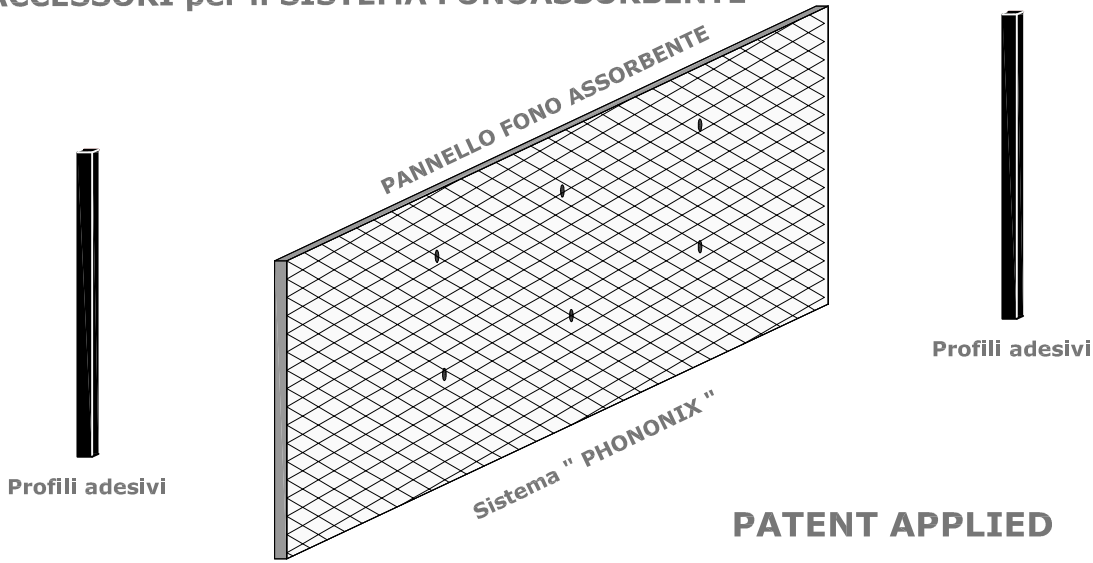

ACCESSORI per l'ASSEMBLAMENTO

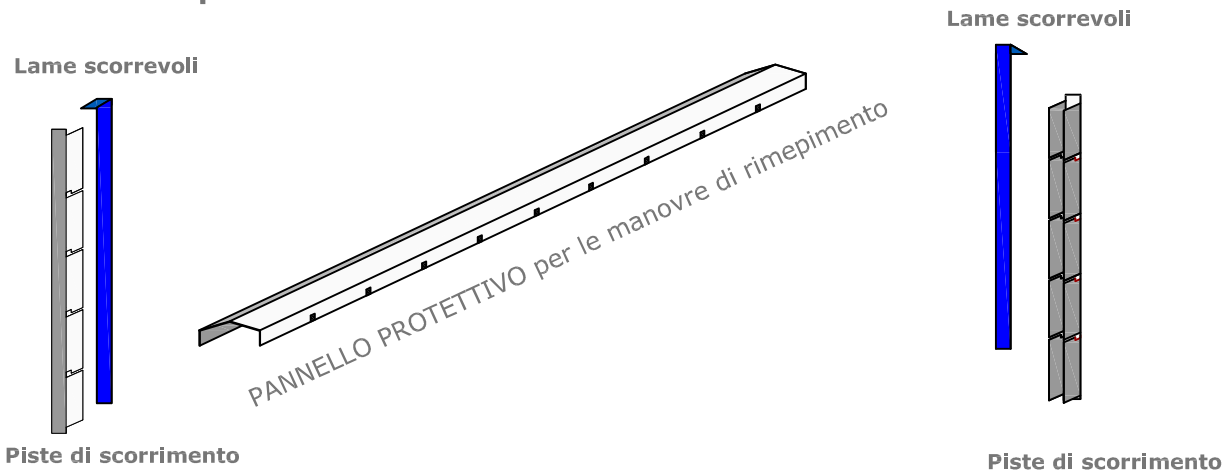

ACCESSORI per le manovre di SOLLEVAMENTO

TRAVERSA DI SOLLEVAMENTO AD H

PETTINI DI SOLLEVAMENTO LSB

